

C130 D 2015

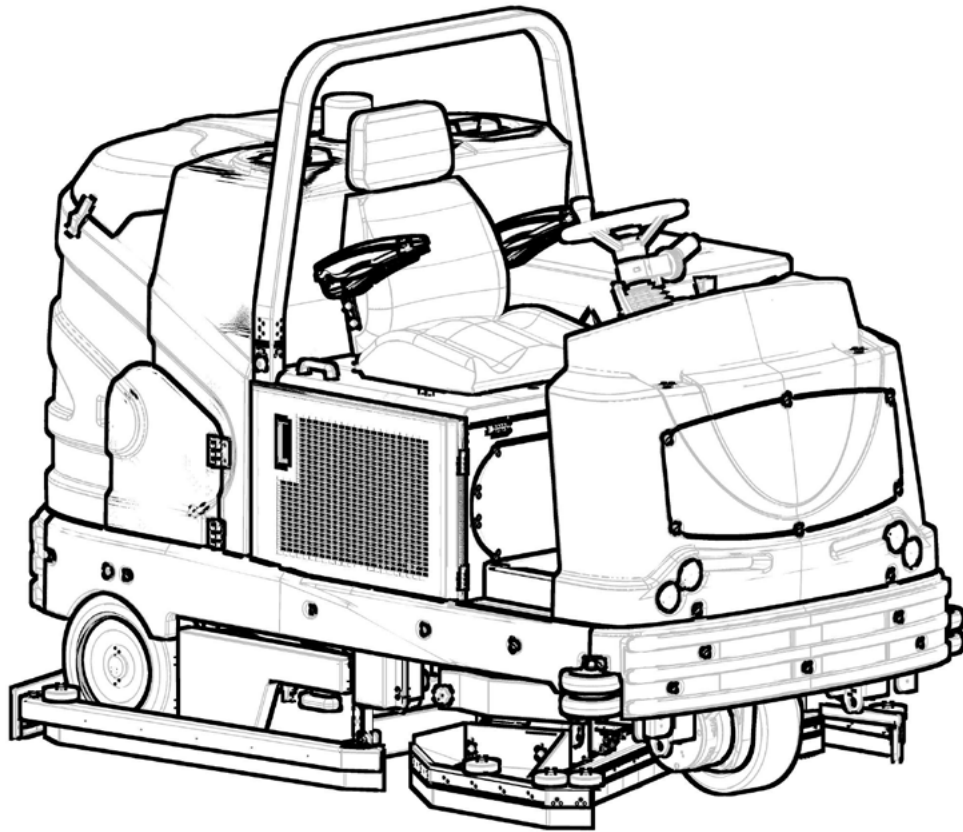

SCRUBBING MACHINES

USE AND MAINTENANCE MANUAL



CONTENTS





CONTENTS	3
GENERAL SAFETY REGULATIONS	3
REFUELLING.....	4
USING THE MACHINE.....	5
DEACTIVATION OF THE MACHINE.....	7
MAINTENANCE.....	7
TRANSPORT.....	9
MAIN MACHINE COMPONENTS	10
MAIN COMPONENTS OF THE COMMAND DISPLAY	11
SYMBOLS USED IN THE MANUAL	12
PURPOSE AND CONTENT OF THE MANUAL	12
TARGET GROUP	12
STORING THE USE AND MAINTENANCE MANUAL	12
ON CONSIGNMENT OF THE MACHINE	12
INTRODUCTORY COMMENT	12
IDENTIFICATION DATA	12
TECHNICAL DESCRIPTION	12
INTENDED USE	12
SAFETY	12
SERIAL NUMBER PLATE	12
TECHNICAL DATA	13
SYMBOLS USED ON THE MACHINE	15
SYMBOLS USED ON THE CONTROL PANEL	15
SYMBOLS USED ON THE SERIAL NUMBER PLATE	16
COMMAND DISPLAY INDICATOR LIGHT SYMBOLS	16
MACHINE PREPARATION	16
HANDLING THE PACKAGED MACHINE.....	16
HOW TO UNPACK THE MACHINE.....	16
HOW TO MOVE THE MACHINE.....	17
MACHINE SAFETY MEASURES.....	18
TYPE OF FUEL TO BE UTILIZED.....	18
REFUELLING.....	18
FILLING THE SOLUTION TANK.....	18
DETERGENT SOLUTION (VERSION WITHOUT CDS).....	19
FILLING THE DETERGENT CANISTER (VERSIONS WITH CDS).....	19
PREPARING TO WORK	19
WORK	19
WORKING PROGRAM: TRANSFER.....	20
WORKING PROGRAM: DRYING.....	21
WORKING PROGRAM: SCRUBBING WITH DRYING.....	22
WORKING PROGRAM: SCRUBBING WITHOUT DRYING.....	23
HOUR METER.....	24
GENERATOR CHARGE LEVEL SIGNALLING DEVICE.....	24
SELECTING THE OPERATING DIRECTION.....	24
ADJUSTING THE OPERATING SPEED.....	25
TEMPORARY ADJUSTMENT OF BRUSH PRESSURE.....	25
TEMPORARILY ADJUSTING THE DETERGENT SOLUTION DISPENSED.....	25
CHECK SCREEN.....	25
CHANGING WORKING PROGRAM PARAMETERS.....	26
DIPPED HEADLIGHTS.....	26
EMERGENCY BUTTON.....	26
BUZZER.....	26
RECOVERY TANK FLOAT.....	26
SOLUTION TANK FLOAT.....	26
ADJUSTMENT OF DRIVING POSITION.....	27
SERVICE BRAKE – PARKING BRAKE.....	27
AT THE END OF THE WORK	27
RECOMMENDED MAINTENANCE OPERATIONS	28
DRAINING THE RECOVERY TANK.....	28
EMPTYING THE DEBRIS HOPPER.....	28
CLEANING THE SQUEEGEE BODY.....	29
CLEANING THE DEBRIS HOPPER.....	29
CLEANING THE DISC BRUSHES.....	30
CLEANING CYLINDRICAL BRUSH.....	30

CLEANING THE RECOVERY TANK FILTER.....	31
CLEANING THE VACUUM MOTOR FILTER.....	31
EMPTYING THE SOLUTION TANK.....	31
CLEANING THE RECOVERY TANK.....	31
CLEANING THE SOLUTION TANK.....	32
CLEANING THE DETERGENT SOLUTION FILTER.....	32
CLEANING THE SQUEEGEE BODY VACUUM TUBE.....	32
CLEANING THE SCRUBBING BRUSH HEAD SPLASH GUARD.....	33
CLEANING SQUEEGEE SPLASH GUARD BARS RUBBER.....	33
CLEANING THE DETERGENT TANK (VERSIONS WITH CDS).....	33
CLEANING THE WATER SYSTEM.....	33
CLEANING THE WATER SYSTEM (VERSIONS WITH CDS).....	34
EXTRAORDINARY MAINTENANCE WORK	35
ASSEMBLING THE SQUEEGEE BODY.....	35
FITTING DISC BRUSHES.....	35
FITTING THE CYLINDRICAL BRUSH.....	35
FITTING THE ROLL BAR.....	36
REPLACING THE DISC BRUSHES.....	36
REPLACING THE CYLINDRICAL BRUSH.....	37
REPLACING THE SQUEEGEE BODY RUBBER BLADES.....	37
REPLACING THE SQUEEGEE SPLASH GUARD BARS RUBBER.....	38
REPLACING THE SCRUBBING BRUSH HEAD SPLASH GUARD RUBBER.....	38
ADJUSTMENT INTERVENTIONS	39
ADJUSTING THE SCRUBBING BRUSH HEAD SPLASH GUARD RUBBER.....	39
ADJUSTING THE SQUEEGEE SPLASH GUARD BAR RUBBER.....	39
ADJUSTING THE SQUEEGEE BODY RUBBER BLADES.....	40
DISPOSAL	40
CHOOSING AND USING THE BRUSHES	40
EC DECLARATION OF CONFORMITY	40
TROUBLESHOOTING	41
BROWSING THE COMMAND DISPLAY MENU	42
CONTROLLER SET.....	42
ALARM.....	43
PROGRAM SET.....	43
HOUR METERS.....	43

GENERAL SAFETY REGULATIONS

The following symbols are used to indicate any potentially hazardous situations. Always read this information carefully and take the necessary precautions to protect any people and/or objects that may be present.

Operator cooperation is paramount for accident prevention. No accident prevention programme can be effective without the full cooperation of the person directly responsible for operating the machine. The majority of occupational accidents that happen either in the workplace or whilst moving are caused by failure to respect the most basic safety rules. An attentive, careful operator is most effective guarantee against accidents and is fundamental in order to implement any prevention programme.

-  **DANGER:** Indicates an imminent danger that could cause serious injury or death.
-  **WARNING:** Indicates a probable dangerous situation that could cause serious injury or death.
-  **CAUTION:** Indicates a probable dangerous situation that could cause minor injuries.
-  **ATTENTION:** Indicates a probable dangerous situation that could damage objects.

REFUELLING

DANGER:

- Gasoline fumes are highly flammable, have a low flashpoint, and are explosive, especially within enclosed environments. Avoid exposing the vapours to any potential source of ignition, as the resulting fire and explosion could result in serious accidents or injuries, or even death.
- Shut off the engine to perform the refuelling operations: the engine generates both extremely high temperatures and electrical sparks. The resulting fire and explosion could result in serious accidents or injuries, or even death.
- The refuelling place must be well aired. Never refuel the engine inside a building where the gasoline fumes could come into contact with flames or sparks.
- Shut off all personal electronic devices, including mobile phones and portable music players, as these could generate electrical sparks. The resulting fire and explosion could result in serious accidents or injuries, or even death. Discharge any static electricity from your body before approaching the fuel tank.
- It is prohibited to smoke, use open flames, or generate sparks in the refuelling area. The resulting fire and explosion could result in serious accidents or injuries, or even death.

WARNING:

- Only use the appropriate containers to transport the fuel, and always remove them from the vehicle before filling them. Any failure to respect this precaution could result in spillage from the container, which in turn could result in a fire.
- You are advised to always put on protective gloves before handling the fuel, to avoid any risk of serious injury to your hands.
- Fuels may contain substances similar to solvents. Avoid any contact of mineral oil products with the skin and eyes. Use gloves when refuelling. Change your protective clothes frequently, and clean them.
- Always open the tank cap carefully, to slowly discharge the overpressure and prevent fuel from spurting out.
- Do not inhale the fuel vapours
- For environmental protection purposes, make sure the fuel doesn't seep into the ground.
- In the event of a fuel spill, clean the machine immediately.
- After refuelling, replace the tank cap.
- Tighten it firmly, but without using tools. The cap must not come loose while the machine is being used.
- Check the tank for any leaks or ineffective seals. If you notice a fuel leakage, do not switch on or use the machine.
- Do not overfill the fuel tank. If too much fuel is added, it could spill out while the vehicle is being driven. The fuel could also spill out due to an increase in volume caused by high ambient temperatures.

- Keep the fuel in containers that meet the legal requisites and bear an identification label.
- The endothermic engine must only be powered using the fuel type described in the use and maintenance manual for the engine itself, which can be found attached to the following booklet.

USING THE MACHINE

DANGER:



- In the event of danger, quickly press the emergency button on the instrument panel.
- Never collect gases, explosive/inflammable liquids or powders, nor acids and solvents! These include gasoline, paint thinners and fuel oil (which, when mixed with the vacuum air, can form explosive vapours or mixtures), and also non-diluted acids and solvents, acetones, aluminium and magnesium powders. These substances may also corrode the materials used to construct the machine.
- If the machine is used in dangerous areas (e.g. petrol stations), the relative safety standards must be observed. It is forbidden to use the machine in environments with a potentially explosive atmosphere.
- The endothermic engine releases toxic and poisonous carbon monoxide gas. Do not use the machine in enclosed and/or poorly ventilated environments.

WARNING:



- The machine must be exclusively used by authorised, trained personnel.
- Do not use the machine on surfaces with a slope greater than the one indicated on the serial number plate.
- The machine is not suitable for cleaning rough or uneven floors. Do not use the machine on slopes.
- In the event of a fire, use a powder extinguisher. Do not use water.
- Adapt the speed to the adhesion conditions.
- In order to prevent the unauthorised use of the machine, the power supply must be disconnected: switch the machine off using the main switch, remove the key from the ignition, and disconnect the generator's connector from the electrical system's connector.
- Do not use the machine if you do not have the requisite knowledge or authorisation.
- Do not use the machine if you have not read and understood the following user manual.
- Do not use the machine under the influence of alcohol or drugs.
- Do not use the machine when using a mobile phone or other electronic devices.
- Do not use the machine if it is not working correctly.
- Do not use the machine in areas where there are inflammable vapours or liquids or combustible powders.
- Do not use the machine in areas that are too dark to see the controls or operate the machine safely, unless the work lights or the front headlights are on.
- Do not use the machine in areas where there is a risk of falling objects, unless the machine is equipped with an overhead guard (optional).

CAUTION:



- Children must be supervised to ensure they do not play with the machine.
- During the working of the machine, pay attention to other people and especially to children.
- Read the labels on the machine carefully. Do not cover them for any reason, and replace them immediately if they become damaged.

- The machine must only be used and stored in an enclosed or covered environment.
- The machine must not be used or stored outdoors in damp conditions or directly exposed to rain.
- The machine does not cause harmful vibrations.
- Use the machine only in the manner described in this manual.
- Do not collect inflammable or steaming refuse, like cigarettes, matches and hot embers.
- Reduce speed along dangerous bends or slopes.
- Reduce speed before turning.
- Stay inside the operator housing when the machine is moving.
- Pay attention when reversing.
- Do not transport passengers.
- Always follow the instructions on the containers for mixing, using and disposing of chemical substances.



ATTENTION:

- When turning on the machine, make sure that the parking brake is engaged and that the direction selection lever is set to its neutral position.
- If the machine is to be used in the presence of other individuals, aside from the operator, the beacon light must be utilized.
- Always take appropriate measures to protect any individuals and/or objects that may be present while using this machine.
- Be careful to avoid collisions with shelving or scaffolding, above all if there is a risk of objects falling from heights.
- Do not place any liquid containers on the machine.
- The machine must only be used under temperature conditions ranging from 0 °C to +40 °C.
- When using detergents to clean the flooring, always follow the instructions and respect the warnings indicated on the containers' labels.
- Always use appropriate gloves and protective equipment when handling the detergents used to clean the floor.
- Do not use the machine as a means of transport.
- Avoid working with the brushes when the machine is standing still, so as not to damage the floor.
- In the event of a fire, use a powder fire extinguisher if possible, and avoid the use of water.
- Do not allow any objects to penetrate into the machine's openings. Do not use the machine if the openings are obstructed.
- Keep the machine's openings free of any dust, lint, hairs, or any other foreign materials that could reduce the airflow.
- Do not remove or alter any labels affixed to the machine.
- This machine has not been approved for use on public streets or roadways.
- Only use the brushes and pad holders that have been supplied along with the machine or those specified in the Operator's Manual. The use of other brushes or felt pads could compromise the machine's safety conditions.
- Before starting work check that there are no leaks.
- Before starting work check that all the safety devices have been installed and are working correctly.
- The hot muffler can cause burns. Do not approach if the engine has been running
- Before starting work check that the brakes and steering are working correctly.
- Before starting work adjust the seat and steering wheel, and also the seat belt if there is one.

DEACTIVATION OF THE MACHINE

WARNING:

- Always protect the machine against sunlight, rain, and other atmospheric agents, both while it is stationary and while it is in function. Store the machine in a dry, sheltered place: this machine is only designed for use under dry conditions, and must not be used or stored outdoors under humid conditions.
- Do not park the machine near combustible materials, powders, gases or liquids.
- Stop the machine on flat ground.
- Engage the parking brake, switch off the machine and remove the key from the instrument panel.
- If the machine is left unattended, it must be protected from any accidental movements.
- In order to prevent the unauthorised use of the machine, the power supply must be disconnected: switch the machine off using the main switch, remove the key from the ignition, and disconnect the alternator's connector from the electrical system's connector

ATTENTION:

- The machine must only be stored under temperature conditions ranging from 0 °C to +40 °C. The humidity level must be between 30% and 95%.
- Never park the machine near any combustible materials, powders, gases or liquids.

MAINTENANCE

DANGER:

- To avoid short-circuits when working in the vicinity of electrical components: avoid the use of non-insulated tools; do not place or allow metallic objects to fall upon the electrically powered components; remove rings, watches and/or clothing with metallic parts that might come into contact with the electrically powered components.
- Do not work underneath the raised machine without adequate fixed safety supports.

WARNING:

- Read all the relevant instructions carefully before performing any maintenance/repair operations.
- If the machine does not work properly, check this is not caused by failure to carry out routine maintenance. Otherwise, ask for the intervention of the authorised technical assistance centre.
- Restore all electrical connections after any maintenance interventions.

CAUTION:

- Disconnect the starter battery's connectors before working on the machine.
- Avoid contact with the acid contained inside the starter battery.
- Avoid contact with moving parts. Do not wear loose clothing or jewellery and tie up long hair.
- Block the wheels before lifting the machine.
- Lift the machine with equipment suitable for the weight to be lifted.



ATTENTION:

- All the activities must be performed under sufficient visibility and lighting conditions.
- Never tamper with the machine's protection devices for any reason; always follow the supplied routine maintenance instructions scrupulously.
- If the machine needs to be pushed for maintenance purposes, never exceed the speed of 4 km/h.
- If any issues are encountered while using the machine, check to make sure that these are not due to a lack of proper maintenance. Otherwise, request the intervention of authorized personnel or an Authorized service centre.
- If any parts need to be replaced, always request ORIGINAL spare parts from an authorized Dealer or Retailer.
- In order to ensure the machine's safety and proper functionality, always have the scheduled maintenance interventions (specified in the appropriate section of this Manual) performed by authorized personnel or by an authorized Service Centre.
- Avoid contact with the engine's hot coolant.
- Never remove the radiator cap while the engine is hot.
- Always allow the engine to cool before starting any maintenance interventions.
- Do not clean the machine with direct or pressurized jets of water, or with corrosive substances.
- Keep all metallic objects at a safe distance from the starter battery.
- Use a non-conductive device for removing the battery.
- Use an adequate tool when lifting the battery.
- The battery should always be installed by qualified personnel.
- Observe the site's safety measures regarding removing the battery.
- Remove the starter battery if the machine needs to be tilted in order to perform maintenance procedures.
- Have the machine checked by an authorised technical assistance centre every year.
- When disposing of consumable materials, observe the laws and regulations in force. Once the machine has reached the end of its service life, the materials contained within it must be disposed of in an appropriate manner, keeping in mind that the machine itself has been built using fully recyclable materials.
- Do not push or tow the machine without an operator in the seat who can control the machine.
- Do not wash the machine with pressurised water or wet the machine near electrical components.
- All repairs should be carried out by qualified personnel.
- Do not physically modify the machine's design features.
- Use spare parts supplied by Comac or by Comac service centres.
- Wear personal protective equipment as required and as recommended in the manual.

TRANSPORT

WARNING:

- Empty both tanks before transporting.
- Put the squeegee and the brushes in their work position before securing the machine to the transport vehicle.
- Use a ramp, a truck or trailer capable of supporting the weight of the machine and the operator.
- Use a winch to put the machine on the transport vehicle. Do not drive the machine onto a truck or a trailer.
- In order to put the machine on the transport vehicle, the ramp should not have such an inclination that the machine gets damaged.
- Engage the parking brake after loading the machine onto the transport vehicle.

ATTENTION:

- The machine must only be stored under temperature conditions ranging from 0 °C to +40 °C. The humidity level must be between 30% and 95%.

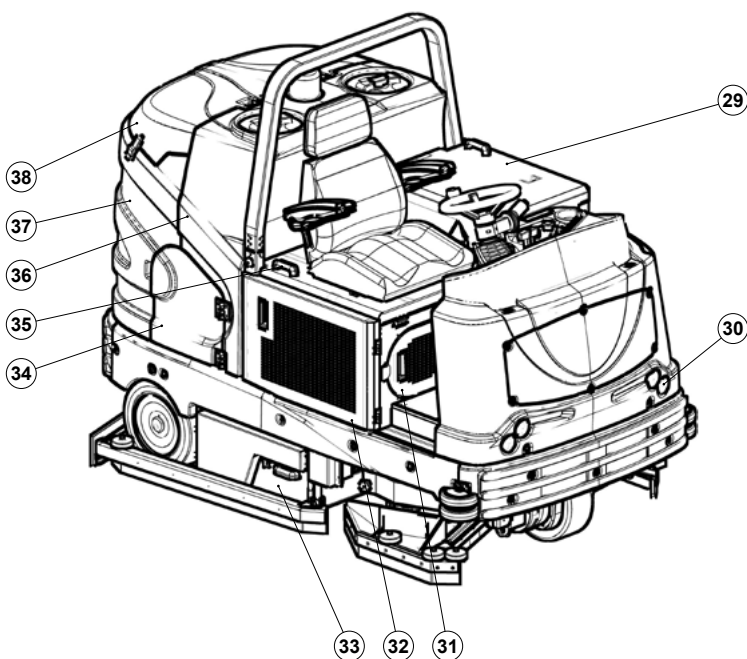
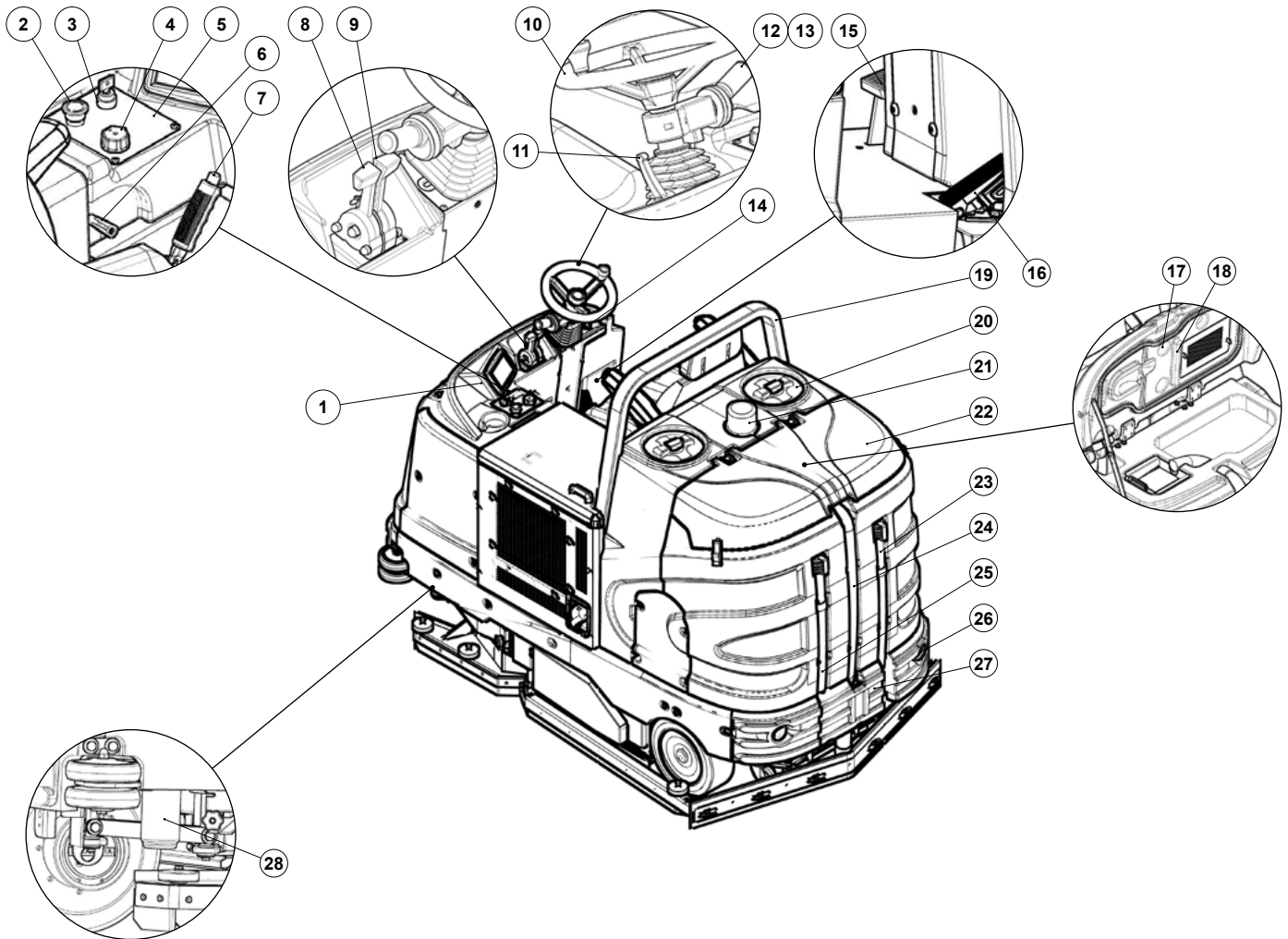

MAIN MACHINE COMPONENTS

The main machine components are the following:

1. Command display.
2. Emergency push button.
3. Main key switch.
4. i-drive selector.
5. Control panel.
6. Detergent solution tap control lever.
7. Parking brake lever.
8. Endothermic engine speed adjustment lever.
9. Endothermic engine starter control lever.
10. Steering wheel.
11. Steering wheel adjustment lever.
12. Lever for adjusting machine direction.
13. Speed adjustment knob.
14. Horn button.
15. Service brake pedal.
16. Drive pedal.
17. Vacuum motor filter retainer.
18. Vacuum motor air intake filter.
19. Roll bar.
20. Solution tank filler cap.
21. Blinking light.
22. Recovery tank lid.
23. Recovery tank drainage hose.
24. Squeegee vacuum hose.
25. Solution tank drain pipe.
26. Rear headlights.
27. Inspection footboard - recovery tank maintenance.
28. Detergent solution filter.
29. Endothermic engine inspection panel.
30. Headlights.
31. Front LPG cylinder inspection panel.
32. Right lateral panel.
33. Debris hopper.
34. Fuel door.
35. Operator seat support panel.
36. Solution tank.
37. Recovery tank.
38. Recovery tank lid.

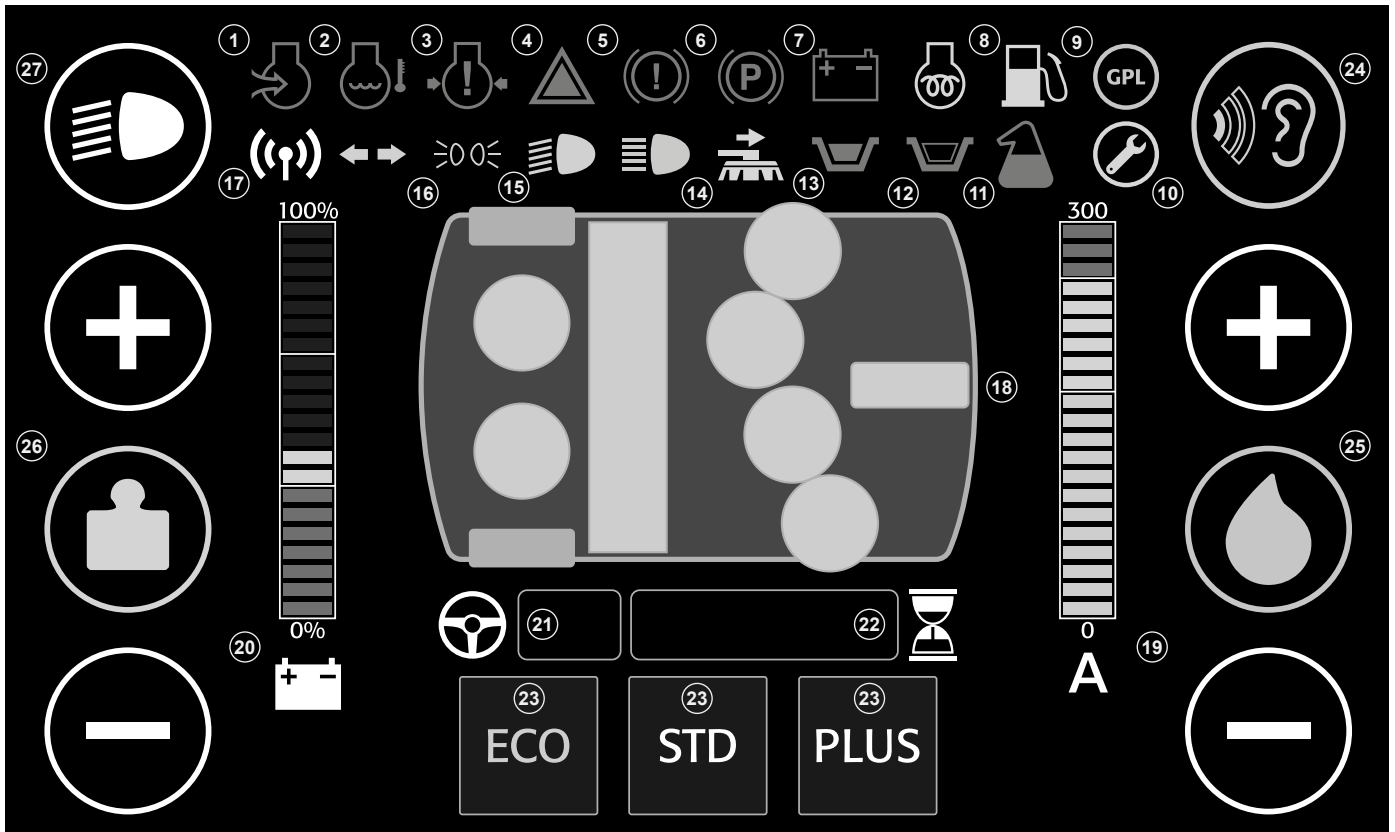

MAIN COMPONENTS OF THE COMMAND DISPLAY

The main machine components are the following:

1. Filter obstruction indicator.
2. Radiator coolant temperature indicator.
3. Oil pressure indicator.
4. General alarm indicator light.
5. Braking system low oil level indicator.
6. Parking brake engaged indicator.
7. Starter battery anomaly alarm indicator.
8. Spark plug indicator.
9. Fuel reserve indicator.
10. Service Warning Time indicator light.
11. Empty detergent canister indicator (CDS system).
12. Solution tank float indicator light.
13. Recovery tank float indicator light.
14. Scrubbing brush head shifting indicator light.
15. Dipped headlights indicator light.
16. Position lights indicator light.
17. CFC system active indicator light.
18. Machine silhouette.
19. Machine's current draw level bar.
20. Generator charge level bar.
21. Direction box.
22. Hour meter box.
23. Pre-set programs (ECO – STD – PLUS).
24. Noise reduction button.
25. Temporary detergent solution flow adjustment button.
26. Button for temporarily adjusting the pressure exercised on the brushes.
27. Activation button – deactivating dipped headlights.
28. Analogue radiator coolant temperature indicator.
29. Analogue and digital endothermic engine speed indicator.
30. Analogue fuel tank level indicator.

The descriptions contained in this document are not binding. The company therefore reserves the right to make any modifications at any time to elements, details, or accessory supply, as considered necessary for reasons of improvement or manufacturing/commercial requirements. The reproduction, even partial, of the text and drawings contained in this document is prohibited by law.

The company reserves the right to make any technical and/or supply modifications. The images are shown as reference only and are not binding as to the actual design and/or equipment.

SYMBOLS USED IN THE MANUAL



Symbol of the open book with i:
Indicates the need to consult the instruction manual.



Symbol of the open book:
Tells the operator to read the user manual before using the device.



Covered place symbol:
The operations preceded by this symbol must always be carried out in a dry, covered area.



Information symbol:
Indicates additional information for the operator, to improve the use of the device.



Warning symbol:
Carefully read the sections preceded by this symbol meticulously following the instructions indicated for the safety of the operator and the device.



Danger symbol (corrosive substances):
The operator should always wear protective gloves to avoid the risk of serious injury to the hands caused by corrosive substances.



Danger symbol (battery acid leakage):
Indicates the danger of leaking acid or acid fumes from the batteries while they are being recharged.



Danger symbol (moving carriages):
Indicates that the packed product should be handled with suitable carriages that conform to legal requirements.



Mandatory room ventilation symbol:
Informs the operator that the room must be ventilated while the batteries are being recharged.



Symbol indicating the compulsory use of protective gloves:
Indicates that the operator should always wear protective gloves, to avoid the risk of serious injury to his hands from sharp objects.



Symbol indicating the compulsory use of tools:
Informs the operator of the need to use tools not included with the machine.



Symbol indicating a treading ban:
Informs the operator that it is forbidden to tread on machine components, as this could lead to serious injury.



Recycling symbol:
Tells the operator to carry out the operations in compliance with environmental regulations in force in the place where the appliance is being used.



Disposal symbol:
Carefully read the sections marked with this symbol for disposing of the appliance.

PURPOSE AND CONTENT OF THE MANUAL

The aim of this manual is to provide customers with all the information needed to use the machine in the safest, most appropriate and most autonomous way. This includes information concerning technical aspects, safety, operation, downtime, maintenance, spare parts and scrapping. The operators and qualified technicians must carefully read the instructions in this manual before carrying out any operations on the machine. If in doubt about the correct interpretation of instructions, contact your nearest Customer Service Centre to obtain the necessary clarifications.

TARGET GROUP

This manual is written both for operators and for qualified machine maintenance technicians. Operators must not perform operations that should be carried out by qualified technicians. The manufacturer is not liable for damages resulting from failure to comply with this veto.

STORING THE USE AND MAINTENANCE MANUAL

The Use and Maintenance Manual must be stored in its special pouch close to the machine, protected from liquids and anything else that could compromise its legibility.

ON CONSIGNMENT OF THE MACHINE

When the machine is consigned to the customer, an immediate check must be performed to ensure all the material mentioned in the shipping documents has been received, and also to check the machine has not suffered damage during transportation. If this is the case, the carrier must ascertain the extent of the damage at once, informing our customer service office. It is only by prompt action of this type that the missing material can be obtained, and compensation for damage successfully claimed.

INTRODUCTORY COMMENT

Any floor scrubbing machine can only work properly and effectively if used correctly and kept in full working order by performing the maintenance operations described in the attached documentation. We therefore suggest you read this instruction booklet carefully and read it again whenever difficulties arise while using the machine. If necessary, remember that our assistance service (organised in collaboration with our dealers) is always available for advice or direct intervention.

IDENTIFICATION DATA

For technical assistance or to request replacement parts, always give the model, the version and the serial number (written on the relevant plate).

TECHNICAL DESCRIPTION

The **C130** is a floor scrubbing machine that can handle a wide variety of floors and types of dirt by using the mechanical action of four disc brushes and the chemical action of a water-detergent solution. As it advances, it collects the dirt that has been removed and the detergent solution not absorbed by the floor. **The machine must only be used for this purpose.**

INTENDED USE

This scrubbing machine was designed and built for the cleaning (scrubbing and drying) of smooth, compact flooring in the commercial, residential and industrial sectors by a qualified operator in proven safety conditions. The scrubbing machine is not suitable for cleaning rugs or carpet floors. It is only suitable for use in closed (or at least covered) places.

ATTENTION: the machine is not suitable for use in the rain, or under water jets.

IT IS FORBIDDEN to use the machine for picking up dangerous dusts or inflammable liquids in places with an explosive atmosphere. In addition, it is not suitable as a means of transport for people or objects.

SAFETY

Operator cooperation is paramount for accident prevention. No accident prevention programme can be effective without the full cooperation of the person directly responsible for machine operation. The majority of occupational accidents that happen either in the workplace or whilst moving are caused by failure to respect the most basic safety rules. An attentive, careful operator is most effective guarantee against accidents and is fundamental in order to implement any prevention programme.

SERIAL NUMBER PLATE

The serial number plate is located underneath the control panel. It indicates the general machine characteristics, in particular the serial number. The serial number is a very important piece of information and should always be provided together with any request for assistance or when purchasing spare parts.

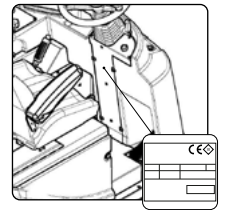

TECHNICAL DATA	S.I. [MKS]	C130 D
Rated machine power	W	7755
Working capacity up to	m ² /h	7800
Working width	mm	1291
Working width with scrubbing brush head shifted outside	mm	1337
Squeegee width	mm	1493
Brushes on brush head (number / Ø external bristles)	No. - Ømm	4 - 345
Rpm of the single brush on the brush head	rpm	220
Brush head engine (voltage / rated power)	V / W	36 - 1125
Sideways movement of scrubbing brush head	mm	120
Sweeping head brush (number -Ø external bristles)	No. - Ømm	1 - 300
Rpm of the sweeping head single brush	rpm	580
Sweeping head engine (voltage - nominal power rating)	V	36 - 750
Debris hopper capacity	l	40
Maximum weight exercised on the brushes (brush head - sweeping head)	kg	180
Traction motor (voltage / rated power)	V / W	36 - 3000
Traction wheel (external Ø / width)	mm	350 - 150
Maximum slope during ascent and descent with the transport programme (weight of the machine when working ⁽⁴⁾)	%	10
Maximum ambient temperature for machine operation	°C	40
Minimum temperature for using the machine's scrubbing functions	°C	0
Rear wheel (external Ø / width)	mm	370 - 140
Maximum forward speed in transport mode	km/h	6
Vacuum motor (voltage - nominal power rating)	V / W	36 - 650
Vacuum head vacuum with STD work program enabled ⁽¹⁾ .	mbar	207
Vacuum head vacuum with STD work program enabled and noise reduction mode selected ⁽¹⁾ .	mbar	169
Maximum solution tank capacity	l	300
Maximum recovery tank capacity	l	360
Detergent tank capacity (versions with CDS)	l	10
Fuel tank capacity	l	22.5
Steering diameter	mm	2560
Machine length	mm	2355
Machine width (with squeegee)	mm	1486
Machine width (without squeegee)	mm	1380
Machine width (with scrubbing brush head shifted outside)	mm	1500
Machine height (without roll bar)	mm	1655
Machine height (with roll bar)	mm	1807
Machine height (with optional roof)	mm	2177
Machine pitch	mm	1589
Machine wheel track	mm	1056
Machine weight ⁽²⁾	kg	1307
Machine weight during transport ⁽³⁾	kg	1330
Machine weight during work operations ⁽⁴⁾	kg	1700
Sound pressure level (ISO 11201) - L _{PA}	dB (A)	<70
Uncertainty K _{PA}	dB (A)	1.5
Hand vibration level (ISO 5349)	m/s ²	<2.5
Body vibration level (ISO 2631)	m/s ²	<0.5
Vibration measurement uncertainty		1.5%



Refer to the endothermic engine's use and maintenance manual for the relative technical data.

Remarks:

- (1) Reading taken from the engine with Ø0 hole.
- (2) Machine weight: refers to the overall weight of the machine with both tanks empty, without the operator onboard, and with the fuel tank empty.
- (3) Machine weight during transport: refers to the overall weight of the machine with both tanks empty, without the operator onboard, and with the fuel tank full.
- (4) Machine weight during work operations: refers to the overall weight of the machine with the solution tank full, with the detergent canister full, with the recovery tank empty, with the weight of the operator onboard (theoretical weight 70kg), and with the fuel tank full.

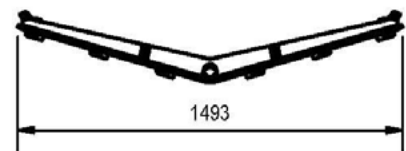
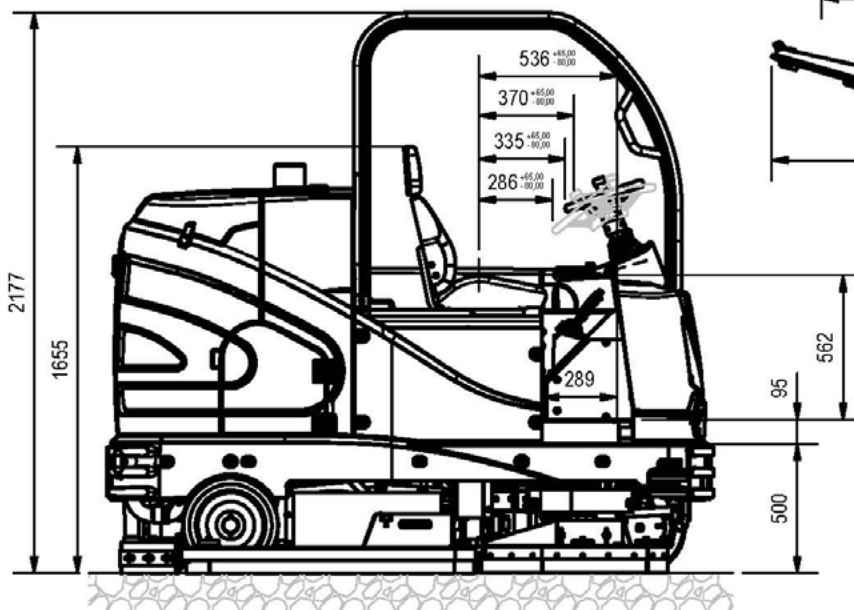
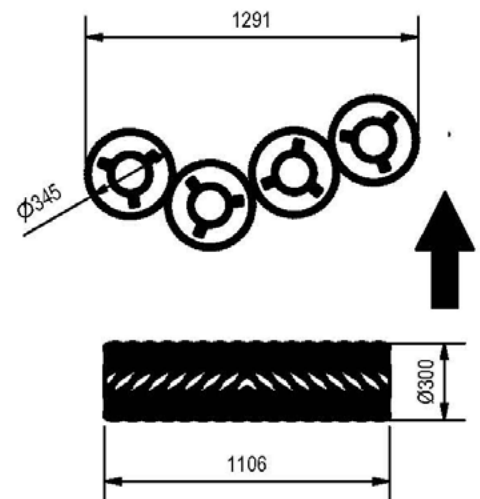
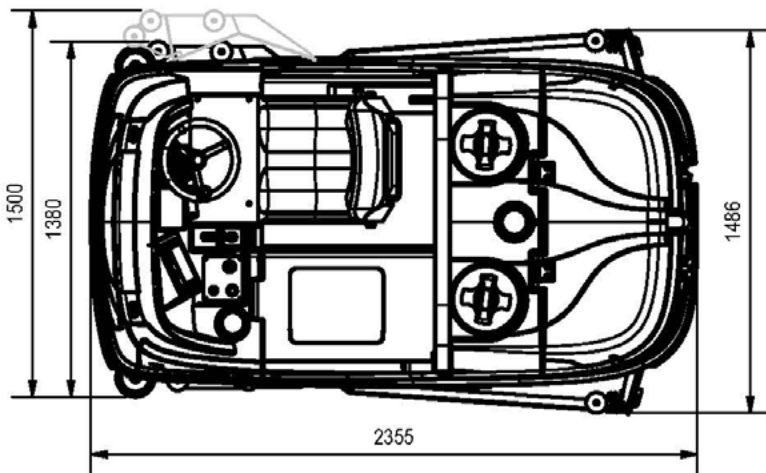
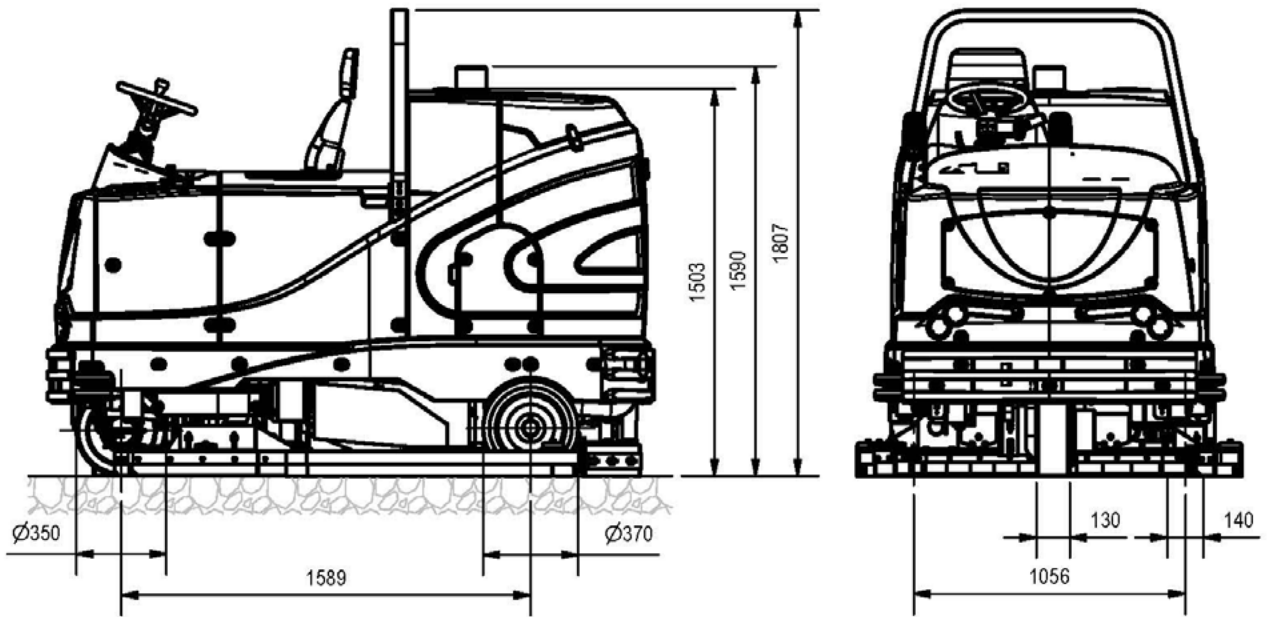

SYMBOLS USED ON THE MACHINE



Inspection ramp label:
Used on the back of the machine to indicate the position of the inspection and recovery tank maintenance footboard.



Lifting hook label:
Used to indicate where to screw in the eye bolts for safely lifting the machine.



Solution tank drainage tube label:
Located on the rear part of the machine, to identify the solution tank drainage tube.



Recovery tank drainage tube label:
Located on the rear part of the machine, to identify the recovery tank drainage tube.



Parking brake lever label:
Located near the operator seat, to identify the command lever of the parking brake.



Braking system oil level check label:
Located near the braking system oil basin, to remind the operator to check the level of oil in the basin.
The bottom part of the label shows the recommended oil for the braking system.



Seat lifting handle label:
Located near the operator's seat to indicated the handle to be used for lifting the seat support plate.



Vacuum motor filter label:
Applied inside the vacuum cover to identify the vacuum motor intake air filter, and also serves to remind the operator to clean the filter after each machine use.



Label warning about the risk of crushed hands:
Indicates danger to hands due to crushing between two surfaces.



Label warning about the risk of crushed limbs:
Indicates danger to limbs due to crushing between two surfaces.



Label warning about sideways brush head movement:
Located on the right-hand side of the machine, to warn that the scrubbing brush head can be shifted sideways.



Label indicating the need to read the Use and Maintenance Manual:
Located near the steering column, to remind the operator to read the Use and Maintenance Manual before using the machine.



Label indicating that flammable/explosive dusts and/or liquids must not be vacuumed:
Located near the steering column, to indicate that it is forbidden to vacuum flammable or explosive dusts or liquids with the machine.



Battery recharging and daily care label:
Located near the steering column, indicating how to recharge the batteries. On the side, it reminds the operator of the need to clean the squeegee body and all the machine filters every day.



Label about detergent solution filter cleaning:
Located on the front left-hand side of the machine, to identify the position of the detergent solution filter and remind the operator to clean it after every machine use.



Treading ban label:
Located on the machine, to identify the surfaces that must not be trodden on (risk of personal injury or damage to the machine).

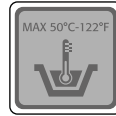

Symbol of maximum temperature for filling the solution tank:
Located on the upper part of the solution tank, to indicate the maximum temperature of the water for filling the solution tank safely.



Detergent canister location label (CDS versions):
Used on the back right of the machine to indicate the chemical detergent canister hatch.

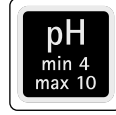

Detergent solution pH label (CDS versions):
Located on the detergent tank cap to indicate the maximum and minimum pH values of the detergent used with the CDS system.

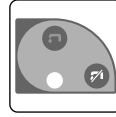

Label for detergent solution tap control:
Located near the operator seat, to identify the command lever for the detergent solution tap.



Label forbidding the use of the machine as a means of transport:
Located on the back of the machine to indicate that the inspection footboard should not be used to transport people.

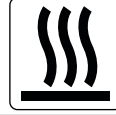

Label warning about the risk of burns:
Used in the vicinity of the endothermic engine to indicate the risk of burns if certain surfaces are touched.



Label warning about the hazard posed by the moving belt and fan:
Used in the vicinity of the endothermic engine's radiator to indicate that the fan and fan belt on the endothermic engine's radiator are in movement, and could pose a serious risk of injury to the limbs.



Label indicating the prohibition to extinguish fires with water:
Used in the vicinity of the endothermic engine's fuel tank to indicate the prohibition to extinguish fires using water.



Label indicating the prohibition to approach with open flames:
Used in the vicinity of the endothermic engine's fuel tank to indicate the prohibition to approach with any type of open flame.

SYMBOLS USED ON THE CONTROL PANEL

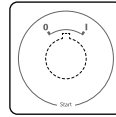

Main switch symbol:
Applied to the control panel, positioned on the front of the machine, to indicate the main switch.

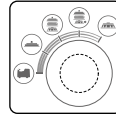

i-drive selector symbol:
Indicates the command knob for the i-drive program selector.



Open book caution symbol:
Used in the control panel to tell the operator to read the manual before using the machine.



Buzzer symbol:
Indicates the buzzer command button.



Endothermic engine speed adjustment command symbol:
Used on the control panel to indicate the endothermic engine's speed adjustment lever.

SYMBOLS USED ON THE SERIAL NUMBER PLATE

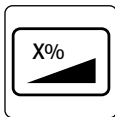

Maximum gradient symbol:
Used on the machine serial number plate, to indicate the maximum gradient that can be safely handled in working mode.

COMMAND DISPLAY INDICATOR LIGHT SYMBOLS



General alarm indicator light (red):
Used on the command display to indicate that a general alarm is in progress.



Braking system oil level indicator light (red):
Used on the command display to indicate that the braking system oil level is low.



Parking brake indicator light (red):
Used on the command display to indicate that the parking brake is engaged.



Starter battery discharged indicator (red):
Used on the command display to indicate that the generator is not recharging the starter battery.



Position lights indicator light (green):
Used on the command display to indicate the position lights are on.



Dipped-beam headlamps indicator light (green):
Used on the command display to indicate the dipped-beam headlamps are on.



Scrubbing brush head shifting indicator light (orange):
Used on the command display to indicate that the scrubbing brush head is shifting sideways.



Recovery tank float indicator light (orange):
Used on the command display to indicate that the recovery tank is full.



Solution tank float indicator light (orange):
Used on the command display to indicate that the detergent solution (versions without CDS) or the water (versions with CDS) has reached the reserve level.



Detergent canister empty indicator light (red):
Used on the command display to indicate that the detergent canister (versions with CDS) has reached the reserve level.



Comac Fleet Care indicator light (white):
Used on the command display to indicate that the Comac Fleet Care function is active.



Service Warning Time indicator light (orange):
Used on the command display to indicate that the Service Warning Time is about to expire.



Endothermic engine air filter obstruction indicator (red):
Used on the command display to indicate that the endothermic engine's air filter is obstructed.



Excessive endothermic engine coolant temperature indicator (red):
Used on the command display to indicate that the endothermic engine's coolant has reached a critical temperature.



Endothermic engine low oil pressure indicator (red):
Used on the command display to indicate low pressure in the endothermic engine's oil circuit.



Endothermic engine low fuel level indicator (yellow):
Used on the command display to indicate that the fuel contained within the fuel tank has reached a critical level.



Endothermic engine spark plug indicator (yellow):
Used on the command display to indicate the heating of the endothermic engine's starter spark plugs.

MACHINE PREPARATION

HANDLING THE PACKAGED MACHINE

The machine's overall weight including packaging is 1440kg.

ATTENTION: it is recommended that all the packaging components be kept for any future machine transportation.

ATTENTION: move the packaged product with handling equipment that complies with legal requirements regarding size and mass of the packaging.

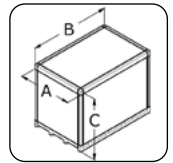

A	1615mm
B	2455mm
C	1860mm

HOW TO UNPACK THE MACHINE

The machine is shipped in specific packaging. To remove it, proceed as follows:

1. Position the packaging in a well-ventilated environment.
2. Place the lower part of the outer packaging in contact with the floor.

NB: use the pictograms printed on the box as a reference.

3. Remove the outer package.

WARNING: the machine is contained in specific packaging materials, whose elements (plastic bags, staples, etc.) can pose potential hazards, and must not be left within reach of children, disabled persons, etc.

4. Remove the headrest, the boxes containing the disc brushes from the machine.
5. From the front of the packaging remove the roll bar.

CAUTION: these operations must be carried out using protective gloves to avoid any possible contact with the edges or tips of metal objects.

6. Insert a ramp in the rear part of the machine.

ATTENTION: the ramp gradient must not be such as to cause damage to the machine as it comes down.

7. The machine is fixed to the pallet with wedges (1) that block the wheels (Fig.1). Remove these wedges.
8. Check the main switch (2) on the control panel is in the "0" position. If this is not the case, turn the key (3) a quarter of a turn to the left (Fig.2). Remove the key from the main switch.
9. Check to make sure that the valve on the endothermic engine's fuel tank is open, and turn the valve's control lever a quarter turn to the left if necessary.
10. Open the right rear door (4) (Fig.3).
11. After having turned the key (6) a quarter turn to the left, remove the fuel tank's cap (5) (Fig.4).
12. Fill the tank with the appropriate fuel.

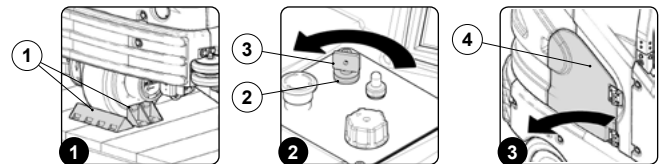

WARNING: refer to the endothermic engine's use and maintenance manual for the type of fuel to be utilized.

WARNING: read the section titled "REFUELLING" before filling the machine's tank.

13. Screw the fuel tank cap (5) back onto the tank, and lock the cap (5) by turning the key (6) a quarter turn to the right.
14. Close the right rear door.
15. Sit on the driver's seat.

N.B.: the machine is equipped with a dead man's micro-switch underneath the seat, which prevents the machine from moving if the driver is not properly seated.

16. Check to make sure that the accelerator lever (7) is set to minimum, otherwise shift it upwards (Fig.5).

WARNING: Prior to activating machine, refer to the endothermic engine's use and maintenance manual, particularly the chapter entitled "OPERATIONAL SAFETY".

17. Insert the key (2) in the main switch (1) on the control panel.
18. Turn the main switch (1) to its "I" position, by turning the key (2) a quarter turn to the right (Fig.6). Turn the key farther to the right to bring the main switch to its START position, and hold it there until the engine starts. you can now release the key.

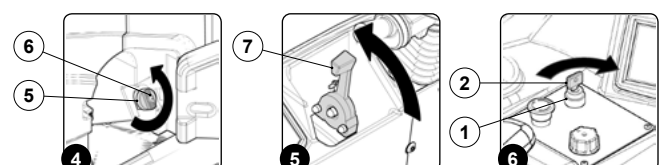

- i** **N.B.:** Wait for the spark plugs symbol on the command display to turn off before turning the main switch to its "START" position.
- i** **N.B.:** Do not use the starter for more than 5 seconds at a time. If the engine does not start up, release the key and wait for 10 seconds before making a new attempt.

19. In order to ensure the machine's proper functionality, once the endothermic engine has been running for a few seconds, move the lever (7) to the end of its stroke (Fig.7). In this manner, the accelerator will be set to its maximum position.

20. Use the i-drive command knob (8) (Fig.8) to select the "transfer" program (A) (Fig.9).

- i** **N.B.:** in this way, both the brush heads and the squeegee support will move to their idle position (raised above the pallet).

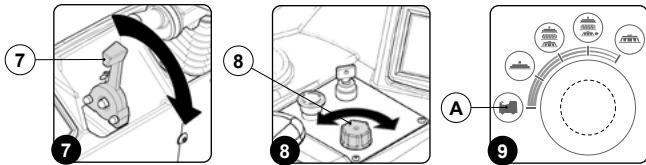

- i** **N.B.:** in the green machine silhouette symbol there will only be the icon regarding the traction motor.
- i** **N.B.:** the grey symbols identify the components that are not active. the green symbols identify the components that are active. the red symbols identify the components that are faulty.

21. Bring the main switch (1) to "0", turning the key (2) a quarter turn to the right (Fig.2). Remove the key from the main switch.

22. Get off the machine.

- !** **CAUTION:** when getting down from the machine do not place your foot on the scrubbing brush head or the squeegee splash guard bar.

23. Remove the scrubbing brush head supports.

24. Remove the squeegee splash guard bar control supports.

25. Remove the squeegee attachment support.

26. Sit on the driver's seat.

27. Insert the key (2) in the main switch (1) on the control panel.

28. Bring the main switch (1) to its "I" position, by turning the key a quarter turn to the right (Fig.6). Turn the key farther to the right to bring the main switch to its START position, and hold it there until the engine starts. you can now release the key.

29. Select the "step-01" speed level, and turn the handle (9) on the direction selection lever (10) (Fig.10), which is located under the steering wheel.

- i** **N.B.:** the number "1" will appear on the command display indicating the selected speed is level one.

30. Shift the direction lever (10) to "reverse", by moving it in the direction shown by the arrow (Fig.11).

- !** **ATTENTION:** To select reverse (R) you need to first shift the lever up and then shift it in the direction indicated by the arrow (Fig.11).

- i** **N.B.:** the letter "R" will appear on the command display indicating that reverse is engaged.

31. Release the parking brake by moving the parking brake lever (11) next to the operator's seat in the direction indicated by the arrow (Fig.12).

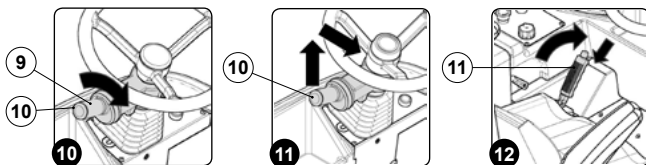

- i** **N.B.:** the symbol regarding the parking brake being engaged will appear on the command display.

32. Press the drive pedal (12) to begin moving the machine (Fig.13).

33. Drive the machine down the ramp.

- !** **CAUTION:** during this operation, check there are no people or objects near the machine.

34. Shift the direction lever (10) to "idle", by moving it in the direction shown by the arrow (Fig.14).

- i** **N.B.:** To select idle (N) move the lever in the direction shown by the arrow.
- i** **N.B.:** the letter "N" will appear on the command display indicating that no gear is engaged.

35. Engage the parking brake by moving the parking brake lever (11) next to the operator's seat in the direction indicated by the arrow (Fig.15).

- i** **N.B.:** the symbol regarding the parking brake being engaged will appear on the command display.

36. Bring the main switch (1) to "0", turning the key (2) a quarter turn to the right (Fig.2). Remove the key from the main switch.

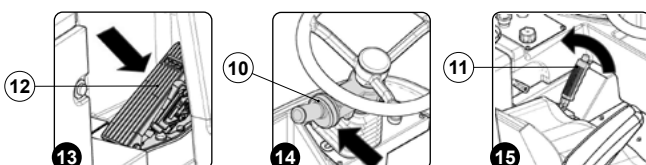

HOW TO MOVE THE MACHINE

To transport the machine safely, proceed as follows:

- !** **N.B.:** before starting any task, make sure the current regulations concerning the safe transport of dangerous substances are scrupulously observed.

1. Check to make sure that the solution tank and the recovery tank are empty. If this is not the case, empty them (see the sections "EMPTYING THE SOLUTION TANK" and "EMPTYING THE RECOVERY TANK" and "EMPTYING THE DEBRIS HOPPER").

2. Sit on the driver's seat.

- i** **N.B.:** the machine is equipped with a dead man's micro-switch underneath the seat, which prevents the machine from moving if the driver is not properly seated.

3. Check to make sure that the accelerator lever (1) is set to minimum, otherwise shift it upwards (Fig.1).

4. Insert the key (2) into the main switch (3) on the control panel.

5. Bring the main switch (3) to its "I" position, by turning the key a quarter turn to the right (Fig.2). Turn the key farther to the right to bring the main switch to its START position, and hold it there until the engine starts. you can now release the key.

- i** **N.B.:** Wait for the spark plugs symbol on the command display to turn off before turning the main switch to its "START" position.

- i** **N.B.:** Do not use the starter for more than 5 seconds at a time. If the engine does not start up, release the key and wait for 10 seconds before making a new attempt.

6. In order to ensure the machine's proper functionality, once the endothermic engine has been running for a few seconds, move the lever (1) to the end of its stroke (Fig.3). In this manner, the accelerator will be set to its maximum position.

7. Use the i-drive command knob (4) (Fig.4) to select the "transfer" program (A) (Fig.5).

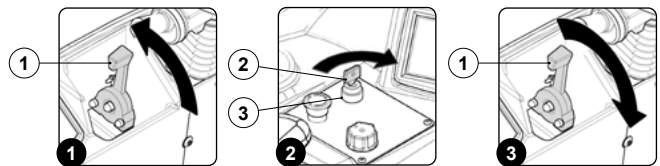

- i** **N.B.:** in this manner, both the brush heads and the squeegee support will move to their idle positions (raised above the floor).

8. Select the speed level (e.g. "step-01") and turn the handle (5) on the direction selection lever (6) (Fig.6) under the steering wheel.

- i** **N.B.:** the number "1" will appear on the command display indicating the selected speed level is the first one.

9. Select the direction in which you want to move the machine. For example, if you want to move forward, shift the direction selector lever (6) in the direction shown by the arrow (Fig.7).

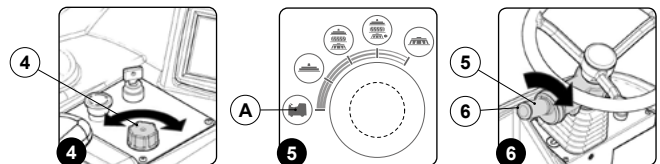

- i** **N.B.:** To select the forward gear (F) you need to first shift the lever up and then shift it in the direction indicated by the arrow (Fig.7).

- i** **N.B.:** the letter "F" will appear on the command display indicating that the forward gear is engaged.

10. Release the parking brake by moving the parking brake lever (7) next to the operator's seat in the direction indicated by the arrow (Fig.8).

- i** **N.B.:** the symbol regarding the parking brake being engaged will appear on the command display.

11. Press the drive pedal (8) to begin moving the machine (Fig.9).

12. Use a ramp to move the machine up onto the transport vehicle.

- !** **CAUTION:** during this operation, check there are no people or objects near the machine.

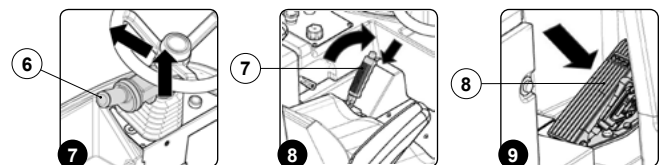

- i** **N.B.:** the ramp gradient must not be such as to cause damage to the machine as it goes up.

13. Place the machine on the transport vehicle.

14. Engage the parking brake by moving the parking brake lever (7), beside of the operator's seat, in the direction shown by the arrow (Fig.10).

- i** **N.B.:** the symbol regarding the parking brake being engaged will appear on the command display.

15. Bring the main switch (3) to its "0" position, by turning the key (2) a quarter turn to the right (Fig.11). Remove the key from the instrument panel.

16. Get off the machine.

CAUTION: when getting down from the machine do not place your foot on the scrubbing brush head or the squeegee splash guard bar.

- Grip the handle (9) and raise the seat mounting plate to the maintenance position (Fig.12).
- Disconnect the generator's connector (10) from the machine's main system connector (11) (Fig.15).

19. Grip the handle and lower the seat mounting plate to its working position.

WARNING: secure the device according to the directives in force in the country of use, so that it cannot slide or tip over.

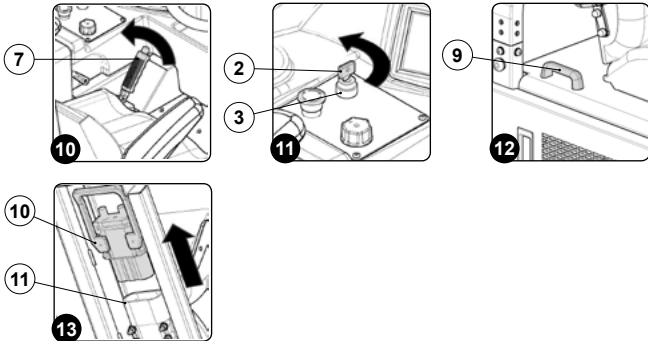

MACHINE SAFETY MEASURES

The procedure for securing the machine, thus allowing the operations to be performed under conditions of complete safety, is as follows:

- Make sure the solution tank is empty. If this is not the case, empty it (read "EMPTYING THE SOLUTION TANK").
- Make sure the recovery tank is empty. If this is not the case, empty it (read "EMPTYING THE RECOVERY TANK").
- Make sure that the debris hopper is empty, and empty it if necessary (read the section "EMPTYING THE DEBRIS HOPPER").
- Shift the direction lever (1) to "idle", moving it in the direction shown by the arrow (Fig.1).
 - N.B.:** to select idle (N) move the lever in the direction shown by the arrow, if for example gear F is engaged (Fig.1).
 - N.B.:** the letter "N" will appear on the command display indicating that no gear is engaged.
- Engage the parking brake by moving the parking brake lever (2) (at the side of the operator seat) in the direction shown by the arrow (Fig.2).
 - N.B.:** the symbol regarding the parking brake being engaged will appear on the command display.
- Bring the main switch (3) to "0", turning the key (4) a quarter turn to the right (Fig.3). Remove the key from the instrument panel.
- Get off the machine.

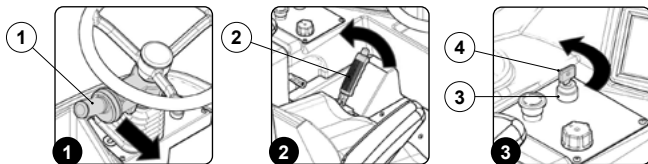

CAUTION: when getting down from the machine do not place your foot on the scrubbing brush head or the squeegee splash guard bar.

- Grip the handle (5) and raise the seat mounting plate to the maintenance position (Fig.4).
- Disconnect the generator's connector (6) from the machine's main system connector (7) (Fig.5).
- Grip the handle (5) and lower the seat mounting plate to the working position.

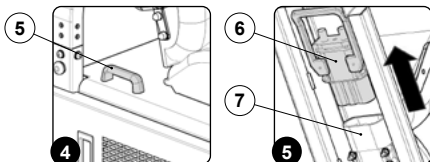

TYPE OF FUEL TO BE UTILIZED

In order to determine which fuel must be utilized to power the machine, please refer to the endothermic engine's use and maintenance manual.

REFUELLING

- DANGER:** Gasoline is highly flammable and explosive. Shut off the engine and allow it to cool before refuelling.
- DANGER:** The refuelling place must be well aired. Never refuel the engine inside a building where the gasoline fumes could come into contact with flames or sparks.
- DANGER:** Gasoline is highly and easily flammable. Keep away from fires and do not shake fuel containers. Don't smoke in the refuelling area! Discharge any static electricity from your body before approaching the fuel tank.
- WARNING:** You are advised to always put on protective gloves before handling the fuel, to avoid any risk of serious injury to your hands. Fuels may contain substances similar to solvents. Avoid any contact of mineral oil products with the skin and eyes. Use gloves when refuelling. Change your protective clothes frequently, and clean them.
- WARNING:** Always open the tank cap carefully, to slowly discharge the overpressure and prevent fuel from spurting out.
- WARNING:** don't inhale the fuel vapours.
- WARNING:** For environmental protection purposes, make sure fuel doesn't seep into the ground.
- WARNING:** In the event of a fuel spill, clean the machine immediately.
- WARNING:** After refuelling, replace the tank cap. Tighten it firmly, but without using tools. The cap must not come loose while the machine is being used.
- WARNING:** Check the tank for any leaks or ineffective seals. If you notice a fuel leakage, do not switch on or use the machine.
- WARNING:** Keep the fuel in containers that meet the legal requisites and bear an identification label.
- WARNING:** The endothermic engine must only be powered using the fuel type described in the use and maintenance manual for the engine itself, which can be found attached to the following booklet.

In order to perform the refuelling operations, do the following:

- Bring the machine to the refuelling area.
- Make sure the machine is in a safe condition (read "MACHINE SAFETY").
- Open the right rear door (1) (Fig.1).
- After having turned the key (3) a quarter turn to the left, remove the fuel tank's cap (2) (Fig.2).
- Fill the tank with the appropriate fuel.
 - WARNING:** Do not overfill the fuel tank. If too much fuel is added, it could spill out while the vehicle is being driven. The fuel could also spill out due to an increase in volume caused by high ambient temperatures.
 - WARNING:** Remember to carefully check the endothermic engine's use and maintenance manual in order to make sure that the correct type of fuel is being used for the refuelling operations. The use of an incorrect type of fuel for the refuelling operations could cause serious damage to the engine and the fuel delivery system.
 - WARNING:** If the refuelling operations are carried out using an incorrect fuel type, the intervention of a qualified technician must be requested before starting the engine. In fact, the engine and the fuel delivery system could be seriously damaged if the engine is started.
- Screw on the fuel tank's cap (2), and turn the key (3) a quarter turn to the right once it has been closed.

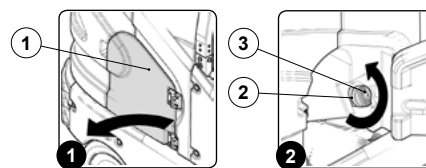

FILLING THE SOLUTION TANK

Before filling the solution tank, carry out the following steps:

- Bring the machine to the area designated for refilling the solution tank.
- Make sure the machine is in a safe condition (read "MACHINE SAFETY").
- Make sure the cap (1) of the solution tank drainage tube (2) is properly tightened (Fig.1).
- Remove the solution tank caps (3) (Fig.2).
- Check that the filters (4) have been positioned correctly (Fig.3).
- Fill with clean water, at a temperature no higher than 50°C and no lower than 10°C.

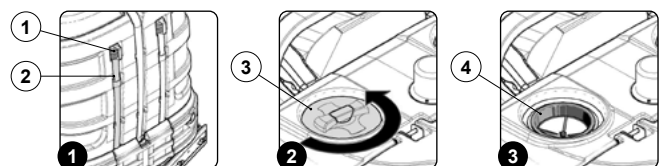

DETERGENT SOLUTION (VERSION WITHOUT CDS)

After filling the solution tank with clean water add the liquid detergent to the tank in the concentration and manner indicated on the detergent manufacturer's label. To prevent the formation of an excessive amount of foam that could damage the vacuum motor, use the minimum percentage of detergent required.

CAUTION: protective gloves should always be worn before handling detergents or acidic or alkaline solutions, to avoid serious injury to the hands.

ATTENTION: always use detergents whose manufacturer's label indicates their suitability for scrubbing machines. Do not use acid or alkaline products or solvents without this indication.

N.B.: always use low-foam detergent. To avoid the production of foam, put a minimum quantity of anti-foam liquid in the recovery tank before starting to clean. Do not use pure acids.

FILLING THE DETERGENT CANISTER (VERSIONS WITH CDS)

After filling the solution tank with clean water, proceed as follows:

1. Bring the machine to the area designated for refilling the solution tank.
2. Make sure the machine is in a safe condition (read "MACHINE SAFETY").

CAUTION: protective gloves should always be worn before handling detergents or acidic or alkaline solutions, to avoid serious injury to the hands.

3. Open the detergent canister hatch (1) on the back right of the machine (Fig.1).
4. Disconnect the male insert (2) from the female insert (3) in the cap (4) of the detergent canister (5) (Fig.2).

N.B.: before pulling on the male insert, push the lever on the female insert.

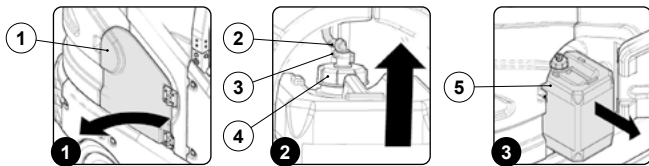

5. Remove the detergent canister (5) from the solution tank compartment (Fig.3).
6. Remove the cap (4) of the detergent canister (Fig.4).
7. Fill the canister with the required detergent.

ATTENTION: always use detergents whose manufacturer's label indicates their suitability for scrubbing machines. Do not use acid or alkaline products or solvents without this indication.

ATTENTION: the dosing system is suitable for frequent maintenance cleaning. Acid or alkaline maintenance detergent tank be used with pH values between 4 and 10 and that do not contain: oxidising agents, chlorine or bromine, formaldehyde, mineral solvents. The detergents used must be suitable for use with scrubbing machines. Wash the circuit with water after use if the system is not used daily. The system can be excluded. In case of sporadic use of detergents with pH between 1-3 or 11-14, use the floor scrubbing machine in the traditional way by adding the detergent in the clean water tank and excluding the dosing circuit.

ATTENTION: always use low-foam detergent. To avoid the production of foam, put a minimum quantity of anti-foam liquid in the recovery tank before starting to clean. Do not use pure acids.

8. Make sure you tighten the cap (4) properly to avoid any liquid leaks when working (Fig.5). Also

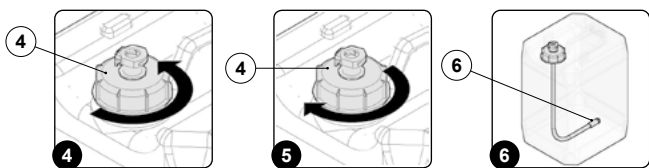

make sure that the detergent intake filter (6) is correctly positioned on the bottom of the canister (Fig.6).

9. Put back the detergent canister (5) in the compartment in the solution tank (Fig.7).
10. Connect the male insert (2) to the female insert (3) in the cap (4) of the detergent canister (5) (Fig.8).
11. Close the chemical detergent canister hatch.

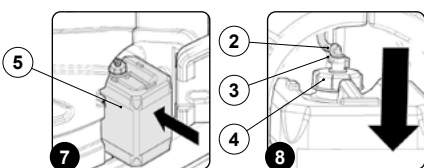

PREPARING TO WORK

Before beginning to work, it is necessary to:

1. Make sure the recovery tank is empty. If this is not the case, empty it (read "EMPTYING THE RECOVERY TANK").
2. Check that the quantity of detergent solution in the solution tank is right for the type of work to be carried out. If necessary, fill the solution tank (for versions without CDS, read "FILLING THE SOLUTION TANK" and "DETERGENT SOLUTION (VERSION WITHOUT CDS)"; for versions with CDS, read "FILLING THE SOLUTION TANK" and "DETERGENT SOLUTION (VERSIONS WITH CDS)").
3. Check that the squeegee rubbers are in good working condition. If not, carry out maintenance (see "REPLACING THE SQUEEGEE BODY RUBBER BLADES").
4. Check that the splash guard bar rubbers are in good working condition. If this is not the case, replace them (see "REPLACING THE SQUEEGEE BODY SPLASH GUARD RUBBER").
5. Check that the splash guard rubbers on the scrubbing brush head body are in good working condition. If this is not the case, replace them (see "REPLACING THE SCRUBBING BRUSH HEAD SPLASH GUARD RUBBER").
6. Check that the disc brushes are in good working condition. If this is not the case, replace them (see "REPLACING THE DISC BRUSH").
7. Make sure that the cylindrical brush is in a good working condition, if not, carry out maintenance (see "REPLACING THE CYLINDRICAL BRUSH").
8. Make sure that the main switch (1) on the control panel is set to "0" (Fig.1), if not, turn the key a quarter turn to the left. Remove the key from the instrument panel.
9. Grip the handle (2) and raise the seat mounting plate to the maintenance position (Fig.2).
10. Connect the battery connector (3) to the machine's main system connector (4) (Fig.3).
11. Grip the handle (2) and lower the seat mounting plate to its working position.

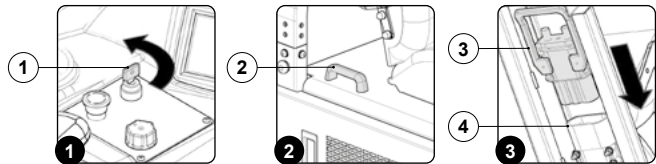

WORK

To start working, do as follows:

1. Make all the checks listed in "PREPARING TO WORK".
2. Sit on the driver's seat.

N.B.: the machine is equipped with a dead man's micro-switch underneath the seat, which prevents the machine from moving if the driver is not properly seated.

3. Check to make sure that the accelerator lever (1) is set to minimum, otherwise shift it upwards (Fig.1).
4. Insert the key (2) into the main switch (3) on the control panel.
5. Bring the main switch (3) to its "I" position, by turning the key a quarter turn to the right (Fig.2). Turn the key farther to the right to bring the main switch to its START position, and hold it there until the engine starts. you can now release the key.

N.B.: Wait for the spark plugs symbol on the command display to turn off before turning the main switch to its "START" position.

N.B.: Do not use the starter for more than 5 seconds at a time. If the engine does not start up, release the key and wait for 10 seconds before making a new attempt.

6. In order to ensure the machine's proper functionality, once the endothermic engine has been running for a few seconds, move the lever (1) to the end of its stroke (Fig.3). In this manner, the accelerator will be set to its maximum position.
7. The first screen shown displays the manufacturer's logo and the name of the machine.

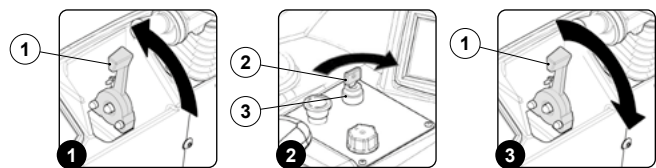

8. The second screen shown contains the parameters for the endothermic engine (Fig.4).

N.B.: Once the endothermic engine's speed is sufficient for generating a voltage greater than 30V, the "Transfer" screen (or the screen relative to the i-drive selector's position) will be automatically displayed.

9. Select the desired work program using the I-Drive device (4) (Fig.5).

The programs that can be selected are (Fig.6):

- A. Transfer: movement of the machine without working.
- B. Drying: using the squeegee only.
- C. Scrubbing with Drying: using both the brushes and the squeegee.
- D. Scrubbing with Drying with lateral shift of the scrubbing brush head: using both the brushes and the squeegee, the scrubbing brush head will shift to the right.
- E. Scrubbing only : using only the brushes in the scrubbing brush head.



- Open the detergent solution flow into the machine's water system by turning the tap control lever (5) in the direction indicated by the arrow (Fig.7).
- Select the speed level (for example "step-01"), and turn the knob (6) on the direction selection lever (7) (Fig.8), under the steering wheel.

i *N.B.:* adjust the forward speed to suit the adhesion conditions.

- Select the direction in which you want to move the machine. For example, if you want to move forward, shift the direction selector lever (7) in the direction shown by the arrow (Fig.9).

i *N.B.:* To select the forward gear (F) you need to first shift the lever up and then shift it in the direction indicated by the arrow (Fig.9).

i *N.B.:* the letter "F" will appear on the command display indicating that the forward gear is engaged.

i *N.B.:* on the command display, near the letter "F" the number "1" is displayed indicating that the forward speed engaged is "step-01".

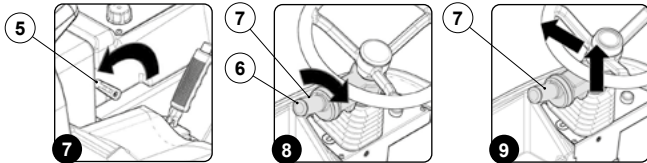

- Release the parking brake by moving the parking brake lever (8) next to the operator's seat in the direction indicated by the arrow (Fig.10).

i *N.B.:* the symbol regarding the parking brake being engaged will appear on the command display.

- Press the drive pedal (9) to begin moving the machine (Fig.11).

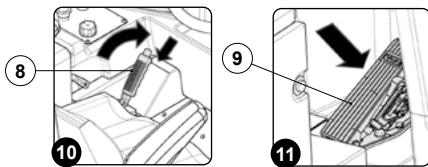

If the working program selected is "SCRUBBING WITH DRYING", the squeegee and brush head will lower until they touch the floor. As soon as the drive pedal is pressed, the traction motor, brush head motor and vacuum motor will start working. As a result, the solenoid valve will also be activated and detergent solution will be dispensed onto the brushes.

During the first few metres, check that there is sufficient solution and that the squeegee is drying correctly.

At this point the machine will begin operating at maximum efficiency until either the detergent solution or both fuels have run out.

Before cleaning, pick up large pieces of waste. Pick up wire, tape, string, large pieces of wood or other refuse that could wrap around the brushes or get entangled.

Drive the machine in a straight line. Avoid hitting obstacles and scratching the sides of the machine. Overlap the cleaning track by a few centimetres.

Avoid turning the steering wheel abruptly when the machine is moving. The machine responds rapidly to the movements of the steering wheel. Avoid hairpin turns, except in emergencies.

Adjust the speed of the machine, the pressure of the brushes and the flow of the solution according to the type of cleaning to be carried out.

Drive the machine slowly on inclines. Use the brake pedal to control the speed when going down an incline. Where there is a slope, carry out the scrubbing by moving the machine upwards rather than downwards.

⚠ **ATTENTION:** when you use the machine, slow down on ramps and slippery surfaces.

Do not use the machine in areas where the ambient temperature is higher than 43 °C (110° F). Do not use the scrubbing functions in areas where the ambient temperature is less than freezing 0 °C (32 °F).

⚠ **ATTENTION:** when using the machine, do not clean on slopes greater than 8.7% or when transporting on slopes greater than 12%.

WORKING PROGRAM: TRANSFER

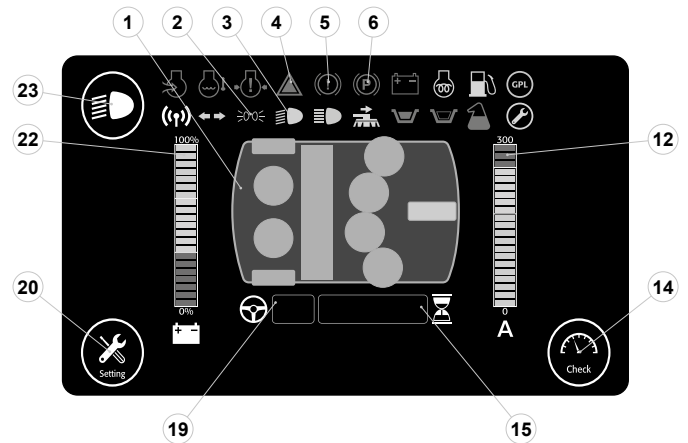

Selecting the program "TRANSFER", the control display screen will appear as shown in the figure. All the brush heads and the squeegee are raised from the floor and do not operate. Le The icons visible in the transfer program are:

- Machine silhouette, where only the icon regarding the traction motor is green.

i *N.B.:* the grey symbols identify the components that are not active, the green symbols identify the components that are active, the red symbols identify the components that are faulty.

- Indicator light indicating the side lights are active (green).
- Indicator light indicating the low beam lights are active (green).
- Indicator light indicating the general alarm (red).
- Indicator light indicating the braking system oil is low (red).
- Indicator light indicating the parking brake is engaged (red).
- Machine's draw level bar.

- Check button, allows you to display the screen regarding the working condition of the machine.

📖 *N.B.:* To understand which parameters are displayed on the screen, read the section "CHECK SCREEN" in the "WORK" chapter.

- Hour meter.

i *N.B.:* the value displayed represents the total time the machine has been used.

- Abbreviation identifying the machine's direction parameters (gear and speed).

📖 *N.B.:* the letter that precedes the number identifies the direction selected, to adjust the direction read the section "SELECTING TRAVEL DIRECTION".

📖 *N.B.:* the number that follows the letter identifies the speed selected, to adjust the speed read the section "ADJUSTING THE SPEED".

- Setting button, allows you to make temporary changes to the machine parameters.
- Battery charge level bar.

📖 *N.B.:* To understand the function of the battery charge level bar, read the section "BATTERY CHARGE LEVEL INDICATOR".

- Activating—deactivating dipped headlights button.

i *N.B.:* setting the main switch to "I" the sidelights will come on. To switch on the low beam headlights press the button (6) on the instrument panel.

i *N.B.:* The low beam headlights are active when the symbol (10) on the instrument panel is green.

To use the transfer program, proceed as follows:

- Sit on the driver's seat.
- Turn on the machine (Fig.1).
- The first screen shown displays the manufacturer's logo and the name of the machine.
- The second screen shown displays the working screen.
- Select the "transfer" program with the knob of the I-Drive device (26) (Fig.2).
- Select the speed level (for example "step-01"), turn the knob (27) on the direction selection lever (28) (Fig.3), under the steering wheel.

i *N.B.:* adjust the forward speed to suit the adhesion conditions.

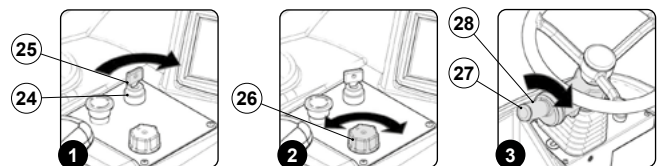

7. Select the direction in which you want to move the machine. For example, if you want to move forwards shift the direction selector lever (29) in the direction shown by the arrow (Fig.4).

i **N.B.:** To select the forward gear (F) you need to first shift the lever up and then shift it in the direction indicated by the arrow (Fig.4).

i **N.B.:** the letter "F" will appear on the command display indicating that the forward gear is engaged (6).

i **N.B.:** on the command display, near the letter "F" the number "1" is displayed indicating that the forward speed engaged is "step-01" (6).

8. Release the parking brake by moving the parking brake lever (30), beside the operator's seat, in the direction shown by the arrow (Fig.5).

i **N.B.:** the symbol regarding the parking brake being engaged will appear on the command display (6).

9. Press the drive pedal (31) to begin moving the machine (Fig.6).

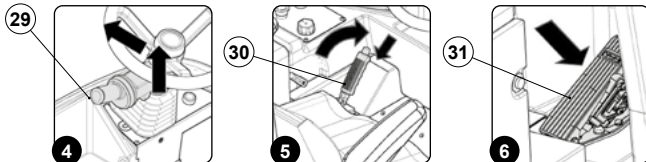

If, when working, it is necessary to use the dipped-beam headlights, press the button (9) on the command display.

i **N.B.:** setting the main switch to "I" the sidelights will come on, and on the instrument panel the relative symbol will come on (2)

i **N.B.:** To access the dipped-beam headlights, press the button (23) on the instrument panel.

i **N.B.:** The low beam headlights are active when the symbol (23) on the instrument panel is green, the relative symbol (4) on the command display comes on.

If, when working, the general alarm indicator light (3) comes on, stop the machine and contact the nearest service centre.

If, when working, the braking system low oil level indicator light (5) comes on, stop the machine and contact the nearest service centre.

i **N.B.:** the symbol (8) is visible on the command display only when the vacuum motors are running.

12. Machine's draw level bar.

14. Check button, allows you to display the screen regarding the working condition of the machine.

i **N.B.:** To understand which parameters are displayed on the screen, read the section "CHECK SCREEN" in the "WORK" chapter.

15. Hour meter.

i **N.B.:** the value displayed represents the total time the machine has been used.

19. Abbreviation identifying the machine's direction parameters (gear and speed).

i **N.B.:** the letter that precedes the number identifies the direction selected, to adjust the direction read the section "SELECTING TRAVEL DIRECTION".

i **N.B.:** the number that follows the letter identifies the speed selected, to adjust the speed read the section "ADJUSTING THE SPEED".

20. Setting button, allows you to make temporary changes to the machine parameters.

22. Battery charge level bar.

i **N.B.:** To understand the function of the battery charge level bar, read the section "BATTERY CHARGE LEVEL INDICATOR".

23. Activating– deactivating dipped headlights button.

i **N.B.:** setting the main switch to "I" the sidelights will come on. To access the dipped-beam headlights, press the button (23) on the instrument panel.

i **N.B.:** The low beam headlights are active when the symbol (2) on the instrument panel is green.

To use the drying program, proceed as follows:

1. Sit on the driver's seat.
2. Turn on the machine (Fig.1).
3. The first screen shown displays the manufacturer's logo and the name of the machine.
4. The second screen shown displays the working screen.
5. Select the "transfer" program with the knob of the I-Drive device (26) (Fig.2).
6. Select the speed level (for example "step-01"), turn the knob (27) on the direction selection lever (28) (Fig.3), under the steering wheel.

i **N.B.:** adjust the forward speed to suit the adhesion conditions.

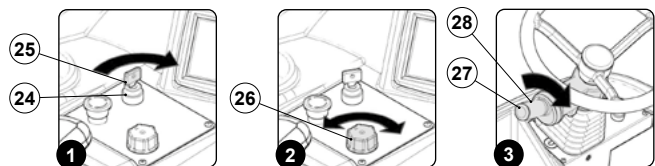

7. Select forward movement by shifting the direction lever (29) in the direction shown by the arrow (Fig.4).

i **N.B.:** to select the forward gear (F) you need to first shift the lever up and then shift it in the direction indicated by the arrow (Fig.4).

i **N.B.:** the letter "F" will appear on the command display indicating that the forward gear is engaged (19).

i **N.B.:** on the command display, near the letter "F" the number "1" is displayed indicating that the forward speed engaged is "step-01" (19).

8. Release the parking brake by moving the parking brake lever (30), beside the operator's seat, in the direction shown by the arrow (Fig.5).

i **N.B.:** the symbol regarding the parking brake being engaged will appear on the command display (6).

9. Pressing the drive pedal (31) (Fig.6), starts the machine moving and the squeegee will go to the work position. As soon as the squeegee body is in the working position the two vacuum motors will start operating.

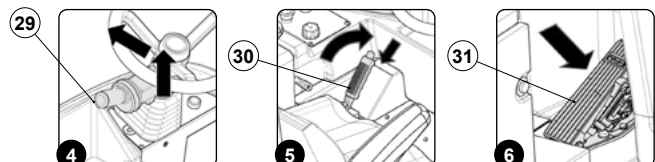

If during the "DRYING" program the machine is stopped and the drive pedal is released, the squeegee body will remain in contact with the floor for a few seconds, after which it will raise up from the ground to go back to its rest position.

In all these phases, the vacuum motors continue to operate, only a few seconds after they return to the rest position do they switch off, this is to allow the motor to collect all the liquid in the vacuum hose. During these phases, the vacuum motor symbol (1) on the command display will be green, it will become grey when the vacuum motor switches off.

i **N.B.:** by pressing the forward movement pedal it will start working with the same program and with the same parameters that were set before it stopped.

WORKING PROGRAM: DRYING

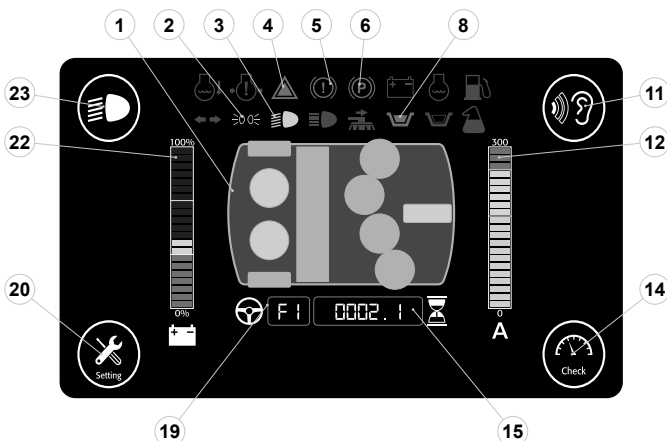

Selecting the program "DRYING", the control display screen will appear as shown in the figure. All the brush heads are raised off the floor and do not operate, while the squeegee body is in the work position and both vacuum motors are running.

! **The drying without scrubbing operation should only be carried out if the device was used beforehand to carry out a scrubbing without drying operation.**

The icons visible in the drying program are:

1. Machine silhouette, where the icon regarding the traction motor and the icons regarding the vacuum motors are green.

i **N.B.:** the grey symbols identify the components that are not active, the green symbols identify the components that are active, the red symbols identify the components that are faulty.

2. Indicator light indicating the side lights are active (green).

3. Indicator light indicating the low beam lights are active (green).

4. Indicator light indicating the general alarm (red).

5. Indicator light indicating the braking system oil is low (red).

6. Indicator light indicating the parking brake is engaged (red).

7. Indicator light indicating the recovery tank is full (light blue).

8. "Noise reduction" button, allows you to reduce the noise of the vacuum motors.

i **N.B.:** the white symbol (8) identifies the standard operation of the vacuum motors, the green symbol (8) identifies the eco operation of the vacuum motors.

i **N.B.:** if reverse is carried out when this program is active, the squeegee body will rise from the floor and the vacuum motors will keep working for a pre-set time and then they will switch off.

If, when working, you need to activate the low beam headlights press the button (23) on the command display.

i **N.B.:** setting the main switch to "I" the sidelights will come on, and on the instrument panel the relative symbol will come on (2)

i **N.B.:** To access the dipped-beam headlights, press the button (23) on the instrument panel.

i **N.B.:** The low beam headlights are active when the symbol (23) on the instrument panel is green, the relative symbol (3) on the command display comes on.

If, when working, the general alarm indicator light (4) comes on, stop the machine and contact the nearest service centre.

If, when working, the braking system low oil level indicator light (5) comes on, stop the machine and contact the nearest service centre.

If, when working, the recovery tank float indicator light (8) comes on, stop the machine and empty the recovery tank.

i **N.B.:** to drain the recovery tank read the section "EMPTYING THE RECOVERY TANK" in the chapter "DAILY MAINTENANCE".

! ATTENTION: never switch off the machine while the squeegee and/or brush head is in contact with the floor

WORKING PROGRAM: SCRUBBING WITH DRYING

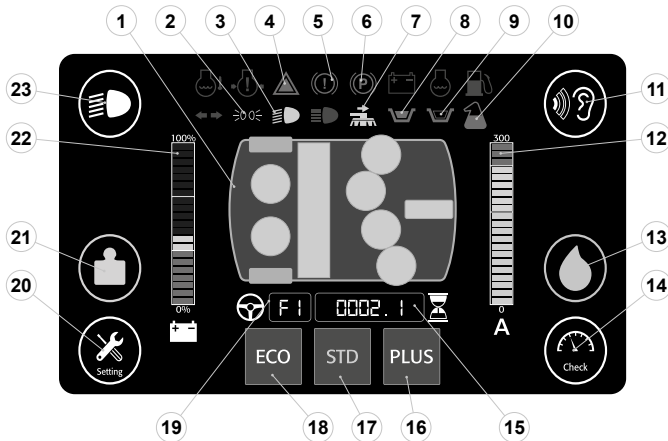

Selecting the program "SCRUBBING WITH DRYING", the control display screen will appear as shown in the figure.

Both the squeegee body and all the brush heads are in contact with the ground. The icons visible in the scrubbing with drying program are:

1. Machine silhouette, where the icon regarding the traction motor is green; the icon for the motors of the scrubbing brush heads; the icon for the motors of the sweeping brush heads and the icons for the vacuum motors.

i **N.B.:** the grey symbols identify the components that are not active. the green symbols identify the components that are active. the red symbols identify the components that are faulty.

2. Indicator light indicating the side lights are active (green).
3. Indicator light indicating the low beam lights are active (green).
4. Indicator light indicating the general alarm (red).
5. Indicator light indicating the braking system oil is low (red).
6. Indicator light indicating the parking brake is engaged (red).
7. Indicator light indicating the scrubbing brush head has moved outside (orange).
8. Indicator light indicating the recovery tank is full (light blue).
9. Indicator light indicating the low level of the detergent solution in the solution tank (light blue).
10. Indicator light indicating the low level of the detergent in the canister (red).
11. "Noise reduction" button, allows you to reduce the noise of the vacuum motors.

i **N.B.:** the white symbol (11) identifies the standard operation of the vacuum motors. the green symbol (11) identifies the eco operation of the vacuum motors.

i **N.B.:** the symbol (11) is visible on the command display only when the vacuum motors are running.

12. Machine's draw level bar.
13. Button for regulating the amount of detergent solution dispensed onto the brushes.

📖 **N.B.:** to temporarily change the amount of detergent solution in the water system read the section "TEMPORARILY ADJUSTING THE DETERGENT SOLUTION DISPENSED" in the chapter "WORK".

14. Check button, allows you to display the screen regarding the working condition of the machine.

📖 **N.B.:** To understand which parameters are displayed on the screen, read the section "CHECK SCREEN" in the "WORK" chapter.

15. Hour meter.

i **N.B.:** the value displayed represents the total time the machine has been used.

16. "PLUS" working program button.
17. "STANDARD" working program button.
18. "ECONOMIC" working program button.

i **N.B.:** the grey symbols identify the components that are not active. the green symbols identify the components that are active.

19. Abbreviation identifying the machine's direction parameters (gear and speed).

📖 **N.B.:** the letter that precedes the number identifies the direction selected, to adjust the direction read the section "SELECTING TRAVEL DIRECTION".

📖 **N.B.:** the number that follows the letter identifies the speed selected, to adjust the speed read the section "ADJUSTING THE SPEED".

20. Setting button, allows you to make temporary changes to the machine parameters.

21. Button for temporarily adjusting the pressure exercised on the brushes.

📖 **N.B.:** to temporarily change the pressure on the brushes, read the sections "TEMPORARY ADJUSTMENT OF BRUSH PRESSURE" in the chapter "WORK".

22. Battery charge level bar.

📖 **N.B.:** To understand the function of the battery charge level bar, read the section "BATTERY CHARGE LEVEL INDICATOR".

23. Activating– deactivating dipped headlights button.

i **N.B.:** setting the main switch to "I" the sidelights will come on, and on the instrument panel the relative symbol will come on (2)

i **N.B.:** To switch on the low beam headlights press the button (23) on the instrument panel, the relative symbol (3) is displayed on the command display

i **N.B.:** The low beam headlights are active when the symbol (23) on the instrument panel is green.

To use the scrubbing with drying program, proceed as follows:

1. Sit on the driver's seat.
2. Turn on the machine (Fig.1).
3. The first screen shown displays the manufacturer's logo and the name of the machine.
4. The second screen shown displays the working screen.
5. Select the "scrubbing with drying" program with the knob of the I-Drive device (26) (Fig.2).
6. Select the speed level (for example "step-01") turn the knob (27) on the direction selection lever (28) (Fig.3), under the steering wheel.

i **N.B.:** adjust the forward speed to suit the adhesion conditions.

7. Select forward movement by shifting the direction lever (28) in the direction shown by the arrow (Fig.4).



i **N.B.:** to select the forward gear (F) you need to first shift the lever up and then shift it in the direction indicated by the arrow (Fig.4).

i **N.B.:** the letter "F" will appear on the command display indicating that the forward gear is engaged (19).

i **N.B.:** on the command display, near the letter "F" the number "1" is displayed indicating that the forward speed engaged is "step-01" (19).

8. Release the parking brake by moving the parking brake lever (29), beside of the operator's seat, in the direction shown by the arrow (Fig.5).

i **N.B.:** the symbol regarding the parking brake being engaged will appear on the command display (6).

9. Select the type of program you want to use, the pre-set program is "STANDARD" (17).

i **N.B.:** the grey symbols identify the components that are not active. the green symbols identify the components that are active.

i **N.B.:** to view or change the parameters of the "ECO" or "STD" or "PLUS" programs read the section "CHANGING WORKING PROGRAM PARAMETERS" in the chapter "WORK".

10. pressing the drive pedal (30) (Fig.6), the machine starts to move, both the brush heads and the squeegee go to the work position, once they are in contact with the floor all the electric motors start operating.

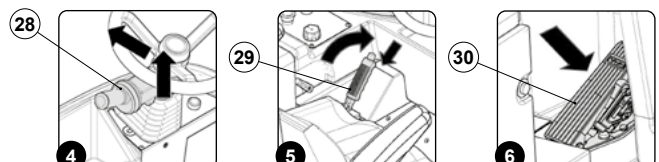

If, when working, you need to temporarily change the parameters of the pressure on the brushes or the amount of detergent solution dispensed, read the sections ["TEMPORARY ADJUSTMENT OF BRUSH PRESSURE"](#) or ["TEMPORARY ADJUSTMENT OF DETERGENT SOLUTION DISPENSING"](#) in the chapter ["WORK"](#).

If, when working, it is necessary to use the dipped-beam headlights, press the button (9) on the command display.

- i** **N.B.:** setting the main switch to "I" the sidelights will come on, and on the instrument panel the relative symbol will come on (2)
- i** **N.B.:** To access the dipped-beam headlights, press the button (23) on the instrument panel.
- i** **N.B.:** The low beam headlights are active when the symbol (23) on the instrument panel is green, the relative symbol (3) on the command display comes on.

If, when working, the machine stops and the drive pedal is released, the brush motors and the solenoid valve will switch off, and after a few seconds the brush heads will raise up off the ground and return to the rest position. The squeegee body will stay in contact with the floor for a few seconds, after which it will raise up from the ground and return to its rest position. For all these phases the vacuum motor will continue to operate, only after a few seconds that it has returned to its work position will it switch off, this is to allow the motor to collect all the liquid in the squeegee vacuum hose.

- i** **N.B.:** by pressing the forward movement pedal it will start working with the same program and with the same parameters that were set before it stopped.
- i** **N.B.:** if reverse movements are made when this program is active, the squeegee body will rise from the floor and the vacuum motors will keep working for a pre-set time and then switch off.
- i** **N.B.:** if reverse is carried out with this program active, the brush head body will remain in contact with the floor, the motor will continue working but the solenoid valve will no longer dispense any detergent solution onto the brushes.

If, when working, you need to reduce the noise of the vacuum motors, press the "Noise reduction" (11) button.

- i** **N.B.:** The "Noise reduction" system is active when the symbol (11) on the instrument panel is green.

If, when working, you need to move the scrubbing brush head to the right, select the "scrubbing with drying, scrubbing brush head moved to the right" program with the knob of the I-Drive device (26) (Fig.2).

- i** **N.B.:** putting the i-drive device (26) knob on "D", the relative symbol (7) on the command display will come on.
- i** **N.B.:** If you release the drive pedal, when working with the scrubbing brush head moved outside, the brush motors and the solenoid valve will switch off, and after a few second the brush heads will raise up off the ground and return to the rest position.

If, when working, the recovery tank float indicator light (8) comes on, stop the machine and empty the recovery tank.

- i** **N.B.:** to drain the recovery tank read the section ["EMPTYING THE RECOVERY TANK"](#) in the chapter ["DAILY MAINTENANCE"](#).

If, when working, the solution tank float indicator light (9) comes on, stop the machine and fill the solution tank.

- i** **N.B.:** to fill the solution tank with detergent solution, refer to ["FILLING THE SOLUTION TANK"](#) in the ["MACHINE PREPARATION"](#) chapter.

If, when working, the general alarm indicator light (4) comes on, stop the machine and contact the nearest service centre.

If, when working, the braking system low oil level indicator light (5) comes on, stop the machine and contact the nearest service centre.

If, when working, the low detergent level indicator light (10) comes on, stop the machine and top up the detergent inside the canister.

! ATTENTION: never switch off the machine while the squeegee and/or brush head is in contact with the floor

WORKING PROGRAM: SCRUBBING WITHOUT DRYING

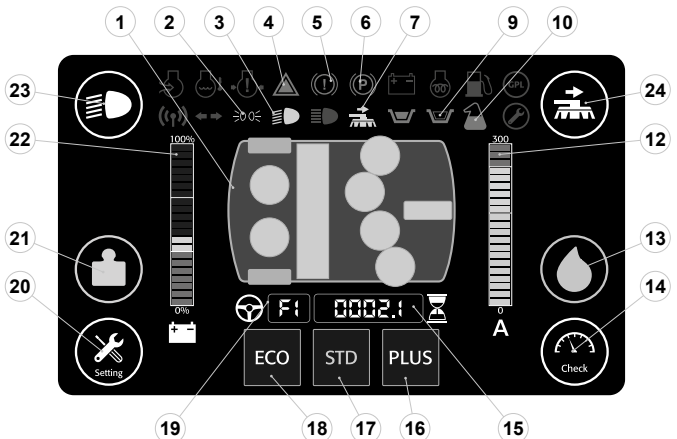

Selecting the program "SCRUBBING WITHOUT DRYING", the control display screen will appear as shown in the figure.

Both the squeegee body and all the brush heads are in contact with the ground. The icons visible in the scrubbing with drying program are:

1. Machine silhouette, where the icon regarding the traction motor is green; the icon for the motors of the scrubbing brush heads; the icon for the motors of the sweeping brush heads.
- i** **N.B.:** the grey symbols identify the components that are not active. the green symbols identify the components that are active. the red symbols identify the components that are faulty.
2. Indicator light indicating the side lights are active (green).
3. Indicator light indicating the low beam lights are active (green).
4. Indicator light indicating the general alarm (red).
5. Indicator light indicating the braking system oil is low (red).
6. Indicator light indicating the parking brake is engaged (red).
7. Indicator light indicating the scrubbing brush head has moved outside (orange).
9. Indicator light indicating the low level of the detergent solution in the solution tank (light blue).
10. Indicator light indicating the low level of the detergent in the canister (red).
11. "Noise reduction" button, allows you to reduce the noise of the vacuum motors.

- i** **N.B.:** the white symbol (11) identifies the standard operation of the vacuum motors. the green symbol (11) identifies the eco operation of the vacuum motors.

- i** **N.B.:** the symbol (11) is visible on the command display only when the vacuum motors are running.

12. Machine's draw level bar.
13. Button for regulating the amount of detergent solution dispensed onto the brushes.

! N.B.: to temporarily change the amount of detergent solution in the water system read the section ["TEMPORARILY ADJUSTING THE DETERGENT SOLUTION DISPENSED"](#) in the chapter ["WORK"](#).

14. Check button, allows you to display the screen regarding the working condition of the machine.

! N.B.: To understand which parameters are displayed on the screen, read the section ["CHECK SCREEN"](#) in the ["WORK"](#) chapter.

15. Hour meter.

- i** **N.B.:** the value displayed represents the total time the machine has been used.

16. "PLUS" working program button.
17. "STANDARD" working program button.
18. "ECONOMIC" working program button.

- i** **N.B.:** the grey symbols identify the components that are not active. the green symbols identify the components that are active.

19. Abbreviation identifying the machine's direction parameters (gear and speed).

! N.B.: the letter that precedes the number identifies the direction selected, to adjust the direction read the section ["SELECTING TRAVEL DIRECTION"](#).

! N.B.: the number that follows the letter identifies the speed selected, to adjust the speed read the section ["ADJUSTING THE SPEED"](#).

20. Setting button, allows you to make temporary changes to the machine parameters.
21. Button for temporarily adjusting the pressure exercised on the brushes.

! N.B.: to temporarily change the pressure on the brushes, read the sections ["TEMPORARY ADJUSTMENT OF BRUSH PRESSURE"](#) in the chapter ["WORK"](#).

22. Battery charge level bar.

! N.B.: To understand the function of the battery charge level bar, read the section ["BATTERY CHARGE LEVEL INDICATOR"](#).

23. Activating-deactivating dipped headlights button.

- i** **N.B.:** setting the main switch to "I" the sidelights will come on, and on the instrument panel the relative symbol will come on (2)

- i** **N.B.:** To switch on the low beam headlights press the button (23) on the instrument panel, the relative symbol (3) is displayed on the command display

- i** **N.B.:** The low beam headlights are active when the symbol (23) on the instrument panel is green.

24. Button for moving the scrubbing brush head.

- i** **N.B.:** If you need to move the scrubbing brush head laterally to the right, press the button (24) on the instrument panel, the relative symbol (7) is displayed on the command display

- i** **N.B.:** The brush head has been moved laterally when the symbol (24) on the instrument panel is green.

To use the scrubbing with drying program, proceed as follows:

1. Sit on the driver's seat.
2. Turn on the machine (Fig.1).
3. The first screen shown displays the manufacturer's logo and the name of the machine.
4. The second screen shown displays the working screen.
5. Select the "scrubbing with drying" program with the knob of the I-Drive device (26) (Fig.2).
6. Select the speed level (for example "step-01"), turn the knob (27) on the direction selection lever (28) (Fig.3), under the steering wheel.
- i** **N.B.:** adjust the forward speed to suit the adhesion conditions.
7. Select forward movement by shifting the direction lever (28) in the direction shown by the arrow (Fig.4).

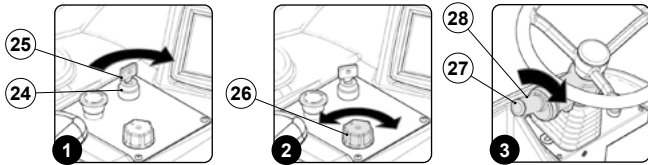

- i** N.B.: to select the forward gear (F) you need to first shift the lever up and then shift it in the direction indicated by the arrow (Fig.4).
- i** N.B.: the letter "F" will appear on the command display indicating that the forward gear is engaged (19).
- i** N.B.: on the command display, near the letter "F" the number "1" is displayed indicating that the forward speed engaged is "step-01" (19).

8. Release the parking brake by moving the parking brake lever (29), beside of the operator's seat, in the direction shown by the arrow (Fig.5).

- i** N.B.: the symbol regarding the parking brake being engaged will appear on the command display (6).

9. Select the type of program you want to use, the pre-set program is "STANDARD" (17).

- i** N.B.: the grey symbols identify the components that are not active. the green symbols identify the components that are active.
- i** N.B.: to view or change the parameters of the "ECO" or "STD" or "PLUS" programs read the section "CHANGING WORKING PROGRAM PARAMETERS" in the chapter "WORK".

10. pressing the drive pedal (30) (Fig.6), the machine starts to move, both the brush heads and the squeegee go to the work position, once they are in contact with the floor all the electric motors start operating.

If, when working, you need to temporarily change the parameters of the pressure on the brushes or the amount of detergent solution dispensed, read the sections "[TEMPORARY ADJUSTMENT OF BRUSH PRESSURE](#)" or "[TEMPORARY ADJUSTMENT OF DETERGENT SOLUTION DISPENSING](#)" in the chapter "WORK".

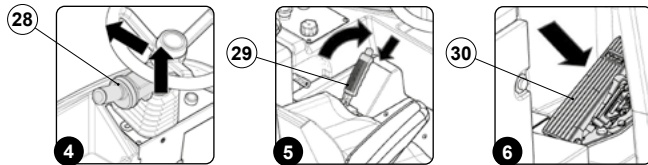

If, when working, it is necessary to use the dipped-beam headlights, press the button (9) on the command display.

- i** N.B.: setting the main switch to "I" the sidelights will come on, and on the instrument panel the relative symbol will come on (2)
- i** N.B.: To access the dipped-beam headlights, press the button (23) on the instrument panel.
- i** N.B.: The low beam headlights are active when the symbol (23) on the instrument panel is green, the relative symbol (3) on the command display comes on.

If, when working, the machine stops and the drive pedal is released, the brush motors and the solenoid valve will switch off, and after a few second the brush heads will raise up off the ground and return to the rest position.

- i** N.B.: by pressing the forward movement pedal it will start working with the same program and with the same parameters that were set before it stopped.
- i** N.B.: if reverse is carried out with this program active, the brush head body will remain in contact with the floor, the motor will continue working but the solenoid valve will no longer dispense any detergent solution onto the brushes.

If, when working, the solution tank float indicator light (9) comes on, stop the machine and fill the solution tank.

- i** N.B.: to fill the solution tank with detergent solution, refer to "[FILLING THE SOLUTION TANK](#)" in the "MACHINE PREPARATION" chapter.

If, when working, the general alarm indicator light (4) comes on, stop the machine and contact the nearest service centre.

If, when working, the braking system low oil level indicator light (5) comes on, stop the machine and contact the nearest service centre.

If, when working, the low detergent level indicator light (10) comes on, stop the machine and top up the detergent inside the canister.

ATTENTION: never switch off the machine while the squeegee and/or brush head is in contact with the floor

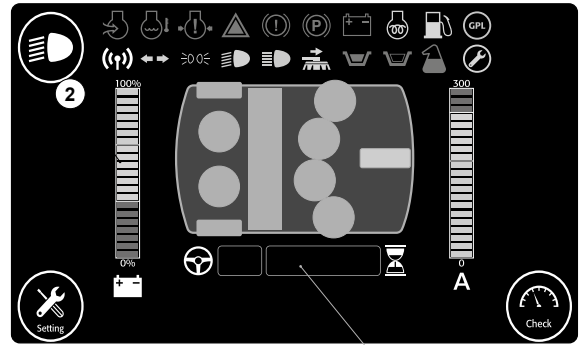

1

HOUR METER

There is a box (1) in the work screen of the command display that allows you to see the total time the machine has been used. The numbers before the letter "h" identify the hours, while the numbers before the letter "m" identify the tenths of an hour (a tenth of an hour corresponds to six minutes). The flashing "." symbol indicates that the hour meter is counting the machine functioning time.

GENERATOR CHARGE LEVEL SIGNALLING DEVICE

The graphical symbol (2), which indicates the generator's charge level, is present on the command display's work screen.

- i** N.B.: Always keep the speed at maximum in order to ensure the generator's proper functionality.

SELECTING THE OPERATING DIRECTION

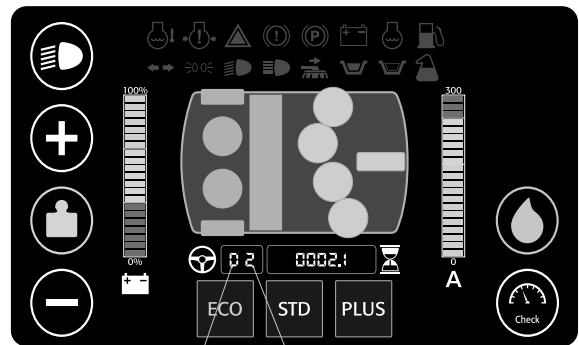

2

4

The machine has a lever for selecting the travel direction (1) under the steering wheel (Fig.1).

- i** N.B.: You can choose between forwards (F) and reverse (R). Putting the lever in the middle however you get neutral (N).
- i** N.B.: to select the forward gear (F) you need to first shift the lever up and then shift it in the direction indicated by the arrow (Fig.1).
- i** N.B.: to go from forward (F) to neutral (N) first move the lever in the direction indicated by the arrow (Fig.2).
- i** ATTENTION: to select reverse (R) you need to first shift the lever up and then shift it in the direction indicated by the arrow (Fig.3). With reverse gear engaged if you press the drive pedal a buzzer will sound and the white rear lights come on.
- i** N.B.: as soon as a gear is selected, the identification letter appears on the command display (2).

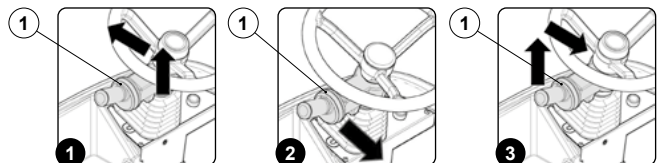

ADJUSTING THE OPERATING SPEED

To adjust the travel speed, use the knob (3) on the gear control lever (1) under the steering wheel (Fig.4).

- i** N.B.: there are three forward speeds.
- i** N.B.: adjust the forward speed to suit the adhesion conditions.
- i** N.B.: as soon as a speed is selected, the identification number appears on the command display (4).

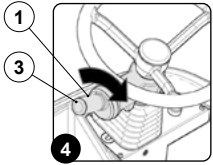

TEMPORARY ADJUSTMENT OF BRUSH PRESSURE

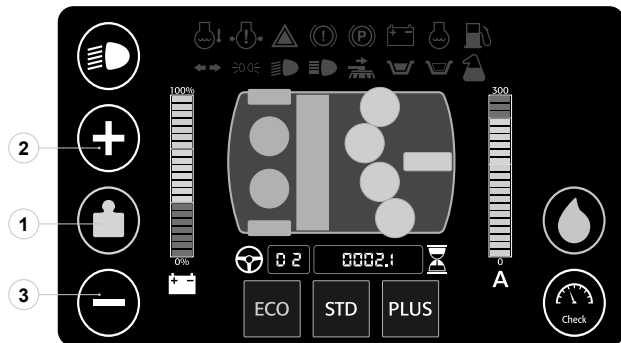

If, when working, you need to temporarily change the pressure exercised on the brushes, just press the button (1) on the command display.

- i** N.B.: pressing the button (1) renders the buttons (2) and (3) visible.
- i** N.B.: pressing the button (2) or button (3) raises (+) or lowers (-) the pressure on the brushes. Each time the buttons (2) or (3) are pressed, the symbol of the button (1) changes.
- i** N.B.: there are three pressure levels: the additional pressure is zero with step-01, and maximum with step-03.
- i** N.B.: the extra pressure should be selected on the basis of the type of floor and the amount of dirt. Remember that increased pressure causes greater wear and tear on the brushes and higher energy consumption.
- i** N.B.: the change of pressure on the brushes is temporary, once the time has passed that was set in the control board parameters, the pressure returns to the value pre-set in the working program being used. To change the length of the temporary adjustment, read the section "CHANGING WORKING PROGRAM PARAMETERS".

TEMPORARILY ADJUSTING THE DETERGENT SOLUTION DISPENSED

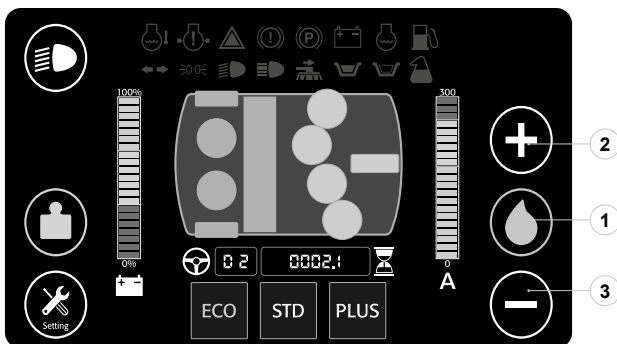

If, when working, you need to temporarily change the dispensing of the detergent solution, just press the button (1) on the command display.

- i** N.B.: pressing the button (1) renders the buttons (2) and (3) visible.
- i** N.B.: pressing the button (+) increases the solution supplied, pressing the button (-) decreases the solution supplied. Every time the buttons (+) or (-) are pressed the button symbol (1) changes.
- i** N.B.: there are six detergent solution supply levels: supply is zero with step-01, and maximum with step-06.
- i** N.B.: the amount of detergent solution should be selected on the basis of the type of floor and the amount and type of dirt to be removed.

- i** N.B.: the modification of the amount of detergent solution is temporary, once the time has passed by the parameters set in the control board, the amount of detergent solution supplied returns to the pre-set value in the working program being used. To change the length of the temporary adjustment, read the section "CHANGING WORKING PROGRAM PARAMETERS".

CHECK SCREEN

If the "CHECK" button is pressed when working the following screen appears:

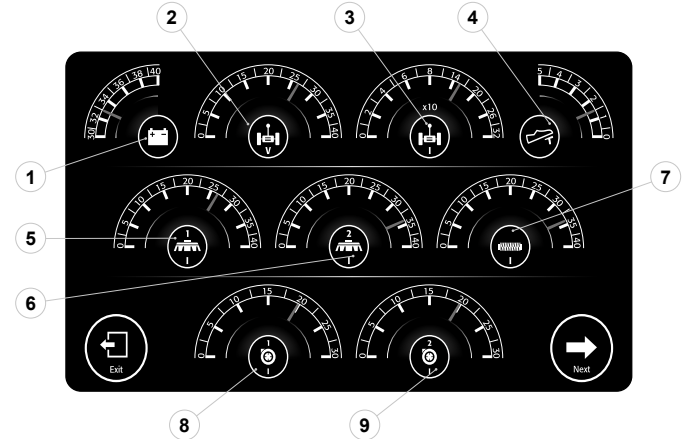

This screen allows you to carry out a diagnosis of the machine. On this screen you can view:

1. The voltage of the batteries.
2. The voltage of the traction motor.
3. The current absorbed by the traction motor.
4. The voltage of the drive pedal.
5. The power consumption of the brush motor, left scrubbing brush head.
6. The power consumption of the brush motor, right scrubbing brush head.
7. The power consumption of the sweeping brush head brush motor.
8. The power consumption of the left vacuum motor.
9. The power consumption of the right vacuum motor.

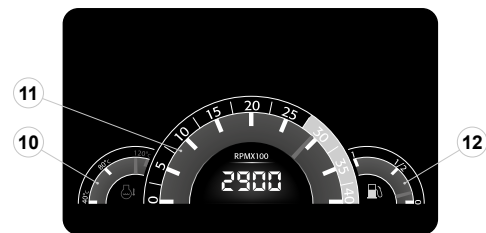

Press the "NEXT" button to switch to the screen for viewing the endothermic engine's parameters, which contains:

10. Endothermic engine coolant temperature level.
11. Endothermic engine speed level.
12. Tank fuel level.



Pressing the "NEXT" button you pass to the screen that allows you to display which digital inputs of the control board are active.

- i** N.B.: the grey symbols identify the components that are not active. the green symbols identify the components that are active. the red symbols identify the components that are faulty.

CHANGING WORKING PROGRAM PARAMETERS

If you need to change the parameters of one of the default programs, do as follows:

1. Press the "SETTING" button on the work screen.
2. As soon as the "SETTING" button is pressed the "MENU" screen is displayed (Fig.1).
3. Press the "PROGRAM SET" button (1) (Fig.1).
4. As soon as the "PROGRAM SET" button is pressed the "SETTING" screen appears (Fig.2).
5. Select the program to be modified:

PLUS= "PLUS" working program button.
 STD= "STANDARD" working program button.
 ECO= "ECONOMIC" working program button.

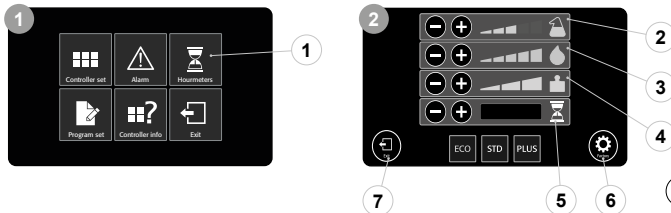

i **N.B.:** the grey symbols identify the components that are not active. the green symbols identify the components that are active.

6. Pressing the symbols "+" and "-" regarding the parameter you want to change, the value displayed is changed.
7. Pressing the "EXIT" button (7) returns you to the "MENU" screen.

i **N.B.:** exiting the "SETTING" screen the changes made are automatically saved.

i **N.B.:** pressing the "FACTORY" button (6) restores factory settings.

i **N.B.:** in this screen it is possible to change the value of the flow of the detergent (2) in the machine's water circuit; the value of the flow of water (3) in the machine's water system; the pressure exercised on the brushes (4); the time for actuating the temporary modifications (5) of the values of the water in the water circuit and the pressure on the brushes.

i **N.B.:** the amount of detergent varies from a minimum of 0.5% to a maximum of 3% with five established dosage levels. The correct flow of detergent should depend on the nature of the floor. It should be proportional to the amount of dirt on the floor and the speed of moving forward, also remember that the time available for working depends on the amount of water in the tank.

i **N.B.:** the amount of water varies from a minimum of 2l/h to a maximum of 10l/h with five established dosage levels. The correct flow of water should depend on the nature of the floor; it should be proportional to the amount of dirt on the floor and the speed of moving forward, also remember that the time available for working depends on the amount of water in the tank.

i **N.B.:** This machine allows you to choose from three different brush pressures by pressing the button (4) on the command display, the amount of pressure should be selected on the basis of the type of floor and the amount of dirt. An increase in pressure could cause greater wear and tear of the brushes and greater energy consumption.

i **N.B.:** the time for actuating the temporary values is expressed in minutes.

i **N.B.:** the "SETTING" screen can be password protected, see the section "[CONTROLLER SET](#)".

DIPPED HEADLIGHTS

The machine is equipped with front and rear headlights. By turning the main switch (1) in the control panel (Fig.1) to position "I" in the control panel (Fig.1), the above-mentioned headlights turn on in sidelights mode. If you need more light in the front of the machine, just press the button (2) on the command display (Fig.2) and the front headlights pass to low beam headlights mode.

i **N.B.:** setting the main switch to "I" the sidelights will come on, and on the instrument panel the relative symbol will come on (3) (Fig.2).

i **N.B.:** To switch on the low beam headlights press the button (2) on the instrument panel, the relative symbol (4) is displayed on the command display Fig.2).

i **N.B.:** The low beam headlights are active when the symbol (2) on the instrument panel is green.

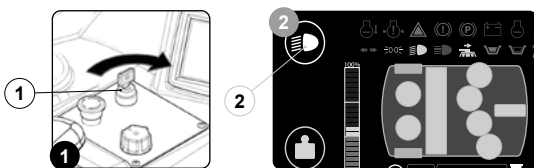

EMERGENCY BUTTON

If, during working, there are any problems press the emergency button (1) on the control panel (Fig.1).

i **N.B.:** As soon as the emergency button (1) is pressed (Fig.1) the machine immediately switches off.

Once you have stopped the machine and solved the problem, to resume work proceed as follows:

1. Turn the main machine switch to "0", turning the key (2) a quarter turn to the left (Fig.2).
2. Set the emergency button (1) to the rest position, turning the key a quarter turn to the right (as indicated by the arrows marked on it) (Fig.3).
3. Turn the main machine switch to "I", making a quarter turn to the right with the key (2) (Fig.4).

i **N.B.:** Use this button only in case of an emergency. The emergency button is not to be used for routinely switching off the machine.

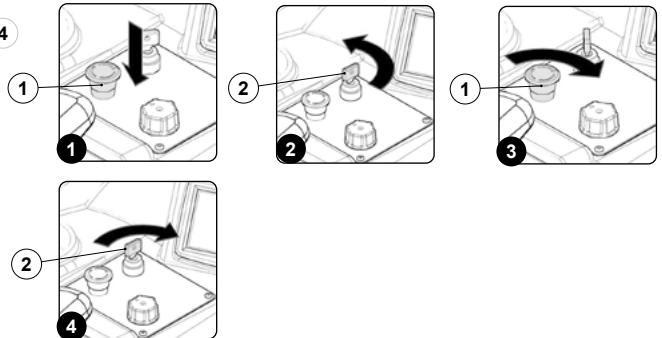

BUZZER

The machine is equipped with a buzzer. If you need to sound a warning, just press the button (1) on the control panel (Fig.1).

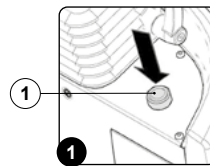

RECOVERY TANK FLOAT

The machine is fitted with an electronic device (float) located inside the recovery tank. When the tank is full, it activates the recovery tank float indicator light (1) on the command display (Fig.1).

If this is the case, proceed as follows:

1. Using the switch on the control panel, select the "TRANSPORT" program (A). The brush motors and solenoid valve will stop working, and after a few seconds the brush head bodies will lift up from the floor. The squeegee will remain in contact with the floor for a few seconds, to allow the drying to finish, after which it will lift up off the floor. A few seconds after the squeegee has reached its idle position, the vacuum motors will stop working; this is to allow all the liquid in the vacuum tube to be vacuumed off.
2. Bring the machine to the designated place for draining off the dirty water, and empty the recovery tank (refer to "[DRAINING THE RECOVERY TANK](#)").

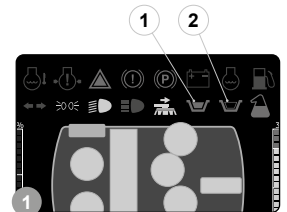

SOLUTION TANK FLOAT

The machine is fitted with an electronic device (float) located inside the solution tank. When the tank is empty, it activates the solution tank float indicator light (2) on the command display (Fig.1).

If this is the case, proceed as follows:

1. Using the switch on the control panel, select the "TRANSPORT" program (A). The brush motors and solenoid valve will stop working, and after a few seconds the brush head bodies will lift up from the floor. The squeegee will remain in contact with the floor for a few seconds, to allow the drying to finish, after which it will lift up off the floor. A few seconds after the squeegee has reached its idle position, the vacuum motors will stop working; this is to allow all the liquid in the vacuum tube to be vacuumed off.
2. Bring the machine to the maintenance area and fill the solution tank with detergent solution (refer to the section titled "[FILLING THE SOLUTION TANK](#)").

i **ATTENTION:** when filling the solution tank, it is good practice to drain the recovery tank using the special drainage tube.

ADJUSTMENT OF DRIVING POSITION

The proper adjustment of the driving position provides a greater sense of comfort when using the machine.

Correct position on the seat: make sure you sit upright and that your back and that your lower back and spine are at 90°.

Seat adjustment: The seat should always be positioned using the pedals as a reference. To adjust the seat use the lever (1) under it (Fig.1).

- i** **N.B.:** The distance should be adjusted so that with the pedals fully pressed to the floor the knees are slightly bent (about 120°).
- i** **N.B.:** Adjust the distance of the seat so that when pressing the brake pedal it goes as far as it can. This operation should be done with the machine running so as to pressurise the braking system.
- i** **N.B.:** If the knee is not bent enough, it is too far from the steering wheel, if however the knee is bent almost 90° then it is too close to the steering wheel.
- i** **N.B.:** The feet should be positioned keeping the heels on the footrest, the sole of the foot directly below the fingers should push the pedals.

Steering wheel adjustment: the inclination of the steering wheel should be adjusted so that you can grip it comfortably.

- i** **N.B.:** To adjust the steering wheel, use the lever (2) on it (Fig.2).
- i** **N.B.:** The ideal position is that which allows you to grip it with the palms slightly lower than the shoulders. With a good grip on the steering wheel, the elbows should be bent by about 120°. They should be at least 30 cm between the middle of the steering wheel and our breastbone. In any case, this distance should be no more than 45 cm.
- i** **N.B.:** After carrying out the adjustment make sure to tighten the lever.

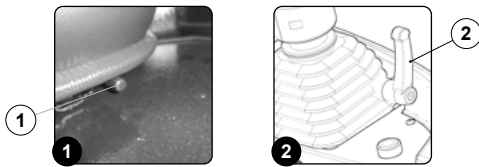

SERVICE BRAKE – PARKING BRAKE

The machine has a service brake pedal (1), to be used to stop the machine when required (Fig.1).

- i** **N.B.:** Pressing the service brake (1) the red rear lights become brighter to indicate that the service brake has been pressed.

The machine has a parking brake lever (2), to be used to stop the machine when it is parked (Fig.1).

- i** **N.B.:** There is a symbol (3) on the command display that indicates whether the parking brake is engaged or not (Fig.2). When the symbol (3) is visible it means the parking brake is engaged.

⚠ ATTENTION: There is an alarm symbol (4) on the command display that indicates that the level of oil in the braking system is low (Fig.2). When the symbol (4) is visible it means that the oil level is low, stop the machine and contact a COMAC service centre.

⚠ ATTENTION: With the parking brake engaged the forward and reverse gears are disabled, pressing the drive pedal the machine does not move.

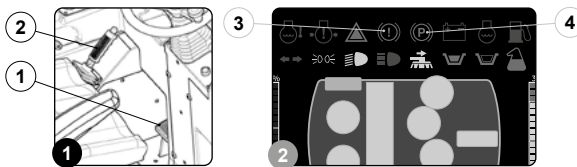

AT THE END OF THE WORK

At the end of the work, and before carrying out any type of maintenance, perform the following operations:

1. Select the i-drive program "transport" by rotating the knob (1) to position "A" as shown in (Fig.1).

- i** **N.B.:** by rotating the i-drive selector to the transfer program, all the brush heads and the squeegee body will move to their idle positions (raised off floor).
- i** **N.B.:** on the screen of the command display, the machine silhouette will have a green icon only the symbol that identifies the traction motor.

2. Take the machine to the maintenance area.

♻ NOTE: the place designated for this operation must comply with current environmental protection regulations.

3. As soon as the machine has reached the maintenance area, carry out the daily maintenance tasks indicated in the table in the chapter "RECOMMENDED MAINTENANCE WORK".

- ⚠ CAUTION:** these operations must be carried out using protective gloves to avoid any possible contact with the edges or tips of metal objects.

4. After completing the tasks listed in the "RECOMMENDED MAINTENANCE WORK" table, grip the handle (2) and raise the seat mounting plate to the maintenance position (Fig.2).
5. Connect the battery connector (3) to the machine's main system connector (4) (Fig.3).

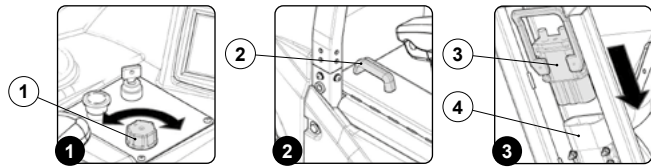

6. Grip the handle (2) and lower the seat mounting plate to the working position (Fig.4).
7. Insert the key (6) into the main switch.
8. Set the main switch (5) to "I", turning the key (6) on the control panel a quarter turn to the right (Fig.5).
9. Take the machine to the designated machine storage place.

⚠ ATTENTION: Park the machine in an enclosed place, on a flat surface; near the machine there must be no objects that could either damage it, or be damaged through contact with it.

10. Shift the direction selector lever (7) in the direction shown by the arrow (Fig.6).

- i** **N.B.:** To select idle (N) move the lever in the direction shown by the arrow (Fig.7).
- i** **N.B.:** the letter "N" will appear on the command display indicating that no gear is engaged.

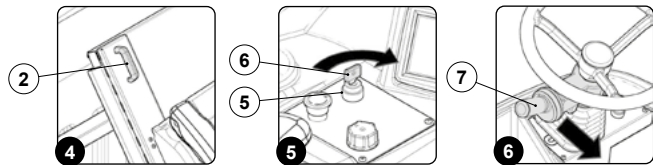

11. Engage the parking brake by moving the parking brake lever (8), beside of the operator's seat, in the direction shown by the arrow (Fig.7).

- i** **ATTENTION:** the symbol regarding the parking brake being engaged will appear on the command display.

12. Bring the main switch (5) to "0", turning the key (6) a quarter turn to the right (Fig.8). Remove the key from the instrument panel.

⚠ ATTENTION: when getting down from the machine do not place your foot on the scrubbing brush head or the squeegee splash guard bar.

14. Grip the handle (2) and raise the seat mounting plate to the maintenance position (Fig.2).
15. Disconnect the battery connector (3) from the main system connector (4) of the machine (Fig.9).

⚠ ATTENTION: when you have finished working, you are advised to rotate the recovery tank lid to the maintenance position to avoid the formation of bad smells inside the tank.

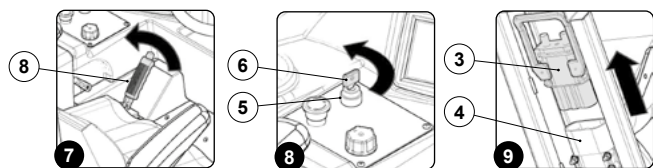

RECOMMENDED MAINTENANCE OPERATIONS

TYPE OF MAINTENANCE	AT THE END OF THE WORK	DAILY	WEEKLY	BEFORE A LONG PERIOD OF NON-USE	TRANSPORT
DRAINING THE RECOVERY TANK	X			X	X
EMPTYING THE DEBRIS HOPPER	X			X	X
CLEANING THE SQUEEGEE BODY	X	X		X	
CLEANING THE DEBRIS HOPPER	X	X		X	
CLEANING DISC BRUSH		X		X	
CLEANING CYLINDRICAL BRUSH		X		X	
CLEANING THE RECOVERY TANK FILTER		X		X	
CLEANING THE VACUUM MOTOR FILTER		X		X	
EMPTYING THE SOLUTION TANK		X		X	X
CLEANING THE SOLUTION TANK			X	X	
CLEANING THE WATER SYSTEM FILTER		X		X	
CLEANING THE VACUUM TUBE			X	X	
CLEANING SCRUBBING BRUSH HEAD SPLASH GUARD RUBBERS			X	X	
CLEANING THE SQUEEGEE BODY SPLASH GUARD BAR RUBBERS			X	X	
CLEANING THE DETERGENT CANISTER (VERSIONS WITH CDS)			X		
CLEANING THE WATER SYSTEM				X	
CLEANING THE WATER SYSTEM (VERSION WITH CDS)				X	

Note:

(1) In any event check the battery charge level when working.



ATTENTION: for the endothermic engine's maintenance operations, please refer to the chapters titled "MAINTENANCE" and "PERIODIC MAINTENANCE" in the engine's use and maintenance manual. This document is furnished along with the machine.

DRAINING THE RECOVERY TANK

Proceed as follows to empty the recovery tank:

- Select the i-drive program "transport" by rotating the knob to position "A" as shown in (Fig.1).

i **N.B.:** by rotating the i-drive selector to the transfer program, all the brush heads and the squeegee body will move to their idle positions (raised off floor).

i **N.B.:** on the screen of the command display, the machine silhouette will have a green icon only the symbol that identifies the traction motor.

- Take the machine to the maintenance area.



NOTE: the place designated for this operation must comply with current environmental protection regulations.

- Make sure the machine is in a safe condition (see "[MACHINE SAFETY MEASURES](#)").



CAUTION: users are advised to always wear protective gloves, to avoid the risk of serious injury to hands.

- Release the recovery tank drainage tube (1) (at the back of the machine) from the retainers (Fig.2).
- Bend the end of the drainage tube, so as to create a choke and prevent the content from coming out (Fig.3), put the tube on the discharge surface and gradually release the tube.



NOTE: the place designated for this operation must comply with current environmental protection regulations.

- Repeat the operations in reverse order to reassemble all the parts.

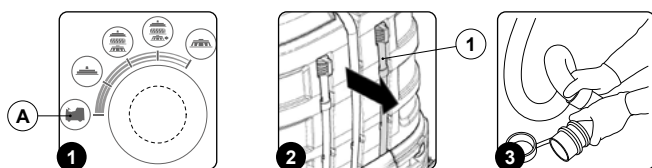

EMPTYING THE DEBRIS HOPPER

To empty the debris hopper, proceed as follows:

- Select the i-drive program "transport" by rotating the knob to position "A" as shown in (Fig.1).

i **N.B.:** by rotating the i-drive selector to the transfer program, all the brush heads and the squeegee body will move to their idle positions (raised off floor).

i **N.B.:** on the screen of the command display, the machine silhouette will have a green icon only the symbol that identifies the traction motor.

- Take the machine to the maintenance area.



NOTE: the place designated for this operation must comply with current environmental protection regulations.

- Shift the direction lever (1) to "idle", moving it in the direction shown by the arrow (Fig.2).

i **N.B.:** to select idle (N) move the lever in the direction shown by the arrow (Fig.2).

i **N.B.:** the letter "N" will appear on the command display indicating that no gear is engaged.

- Engage the parking brake by moving the parking brake lever (2), beside the operator's seat, in the direction shown by the arrow (Fig.3).

i **N.B.:** the symbol for the parking brake being engaged will appear on the command display.

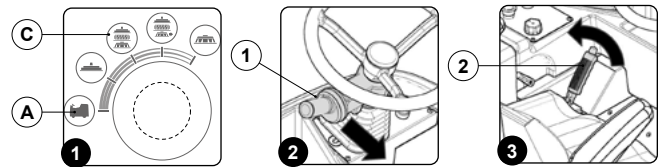

- Select the i-drive program "scrubbing with drying" by rotating the knob to position "C" as shown in (Fig.1).

i **N.B.:** rotating the i-drive selector to the scrubbing with drying program, all the brush heads and squeegee body will move to their working positions (in contact with the floor).

- Press the drive pedal (3) to move both the squeegee body and the brush head bodies to their working positions (Fig.4).

i **N.B.:** on the screen of the command display, the machine silhouette will have a green icon, the symbol that identifies the traction motor; the symbols that identify the motors of the scrubbing brush head; the symbols that identify the motor of the sweeping brush head; the symbols that identify the vacuum motors.

- As soon as the brush head and splash guard bars are in the working position, make sure the machine is in a safe condition (read "[MACHINE SAFETY](#)").



CAUTION: these operations must be carried out using protective gloves to avoid any possible contact with the edges or tips of metal objects.

- Stand on the right side of the machine.
- Remove the retainer (4) from the pin (5) in the squeegee body (Fig.5).
- Free the pin (5) in the squeegee body from the eyelet (6) in the squeegee control bar (Fig.6).
- Turn the right splash guard bar (7) as far as it will go.
- Using the handle (8) in the debris hopper take out the brush head pre-assembly, remembering to pull down the retainer (9) before pulling the brush head out of the machine (Fig.7).
- Using the handles (8) on the side of the debris hopper, take it to a suitable place and empty it.
- Repeat the operations in reverse order to reassemble all the parts.

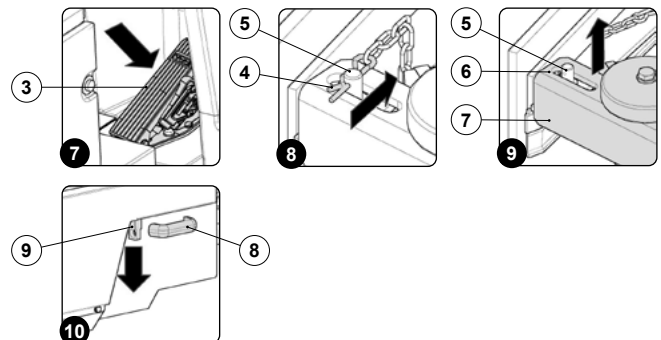

CLEANING THE SQUEEGEE BODY

Careful cleaning of the squeegee body guarantees better cleaning and drying of the floor as well as a longer vacuum motor life.

To carry out the cleaning of the squeegee body, proceed as follows:

- Select the i-drive program "transport" by rotating the knob to position "A" as shown in (Fig.1).
 - N.B.:** by rotating the i-drive selector to the transfer program, all the brush heads and the squeegee body will move to their idle positions (raised off floor).
 - N.B.:** on the screen of the command display, the machine silhouette will have a green icon only the symbol that identifies the traction motor.
- Take the machine to the maintenance area.
 - NOTE:** the place designated for this operation must comply with current environmental protection regulations.
- Shift the direction lever (1) to "idle", moving it in the direction shown by the arrow (Fig.2).
 - N.B.:** to select idle (N) move the lever in the direction shown by the arrow (Fig.2).
 - N.B.:** the letter "N" will appear on the command display indicating that no gear is engaged.
- Engage the parking brake by moving the parking brake lever (2), beside the operator's seat, in the direction shown by the arrow (Fig.3).
 - N.B.:** the symbol regarding the parking brake being engaged will appear on the command display.

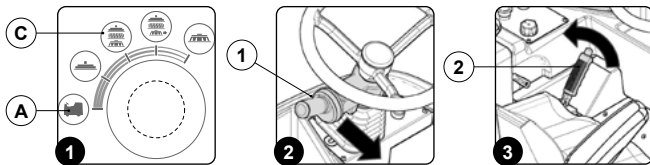

- Select the i-drive program "scrubbing with drying" by rotating the knob to position "C" as shown in (Fig.1).
 - N.B.:** rotating the i-drive selector to the scrubbing with drying program, all the brush heads and squeegee body are in their working positions.
- Press the drive pedal (3) to move both the squeegee body and the brush head bodies to their working positions (Fig.4).
 - N.B.:** in the command display there are visible in green the symbols for the vacuum motors and the brush head motors.
- As soon as the brush head and splash guard bars are in the working position, make sure the machine is in a safe condition (read "MACHINE SAFETY").
 - CAUTION:** these operations must be carried out using protective gloves to avoid any possible contact with the edges or tips of metal objects.
- Stand on the right side of the machine.
- Remove the retainer (4) from the pin (5) in the squeegee body (Fig.5).
- Free the pin (5) in the squeegee body from the eyelet (6) in the squeegee control bar (7) (Fig.6).

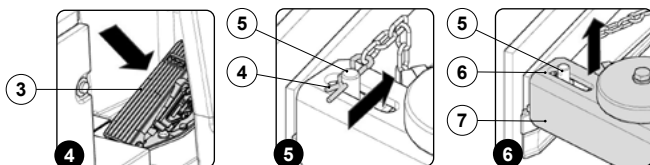

- Repeat steps nine and ten on the left-hand side of the machine.
- Insert the vacuum tube (8) in the sleeve in the squeegee body (Fig.7).
- Using the specific tool loosen the screws (9) in the squeegee body pre-assembly (Fig.8).
 - N.B.:** the equipment to be used for this operation is not supplied with the machine.
- Remove the squeegee body from the support in the machine.
- Use a jet of water and then a damp cloth to thoroughly clean the vacuum chamber (10) of the squeegee body (Fig.9).

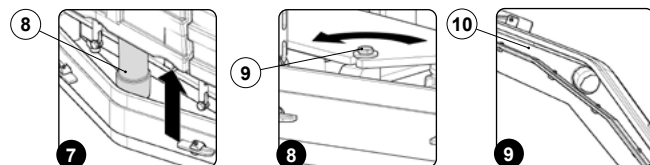

- Use a jet of water and then a damp cloth to thoroughly clean the front rubber blade (11) of the squeegee body (Fig.10).
- Check the wear of the front rubber blade (11) on the squeegee body; if the edge of the rubber in contact with the floor is worn, replace it. Refer to "REPLACING THE SQUEEGEE UNIT RUBBER BLADES".
- Use a jet of water and then a damp cloth to thoroughly clean the rear rubber blade (12) of the squeegee body (Fig.11).

- Check the wear of the rear rubber blade (12) on the squeegee body; if the edge of the rubber in contact with the floor is worn, replace it. Refer to "REPLACING THE SQUEEGEE UNIT RUBBER BLADES".
- Use a jet of water and then a damp cloth to thoroughly clean the vacuum nozzle (13) (Fig.12).
- Repeat the operations in reverse order to refit everything (read the section "FITTING THE SQUEEGEE BODY").

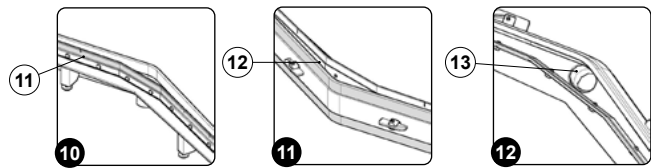

CLEANING THE DEBRIS HOPPER

Careful cleaning of the debris hopper guarantees better drying and cleaning of the floor as well as a longer vacuum motor life.

To clean the debris hopper, proceed as follows:

- Select the i-drive program "transport" by rotating the knob to position "A" as shown in (Fig.1).
 - N.B.:** by rotating the i-drive selector to the transfer program, all the brush heads and the squeegee body will move to their idle positions (raised off floor).
 - N.B.:** on the screen of the command display, the machine silhouette will have a green icon only the symbol that identifies the traction motor.
- Take the machine to the maintenance area.
 - NOTE:** the place designated for this operation must comply with current environmental protection regulations.
- Shift the direction lever (1) to "idle", moving it in the direction shown by the arrow (Fig.2).
 - N.B.:** to select idle (N) move the lever in the direction shown by the arrow (Fig.2).
 - N.B.:** the letter "N" will appear on the command display indicating that no gear is engaged.
- Engage the parking brake by moving the parking brake lever (2), beside the operator's seat, in the direction shown by the arrow (Fig.3).
 - N.B.:** the symbol for the parking brake being engaged will appear on the command display.

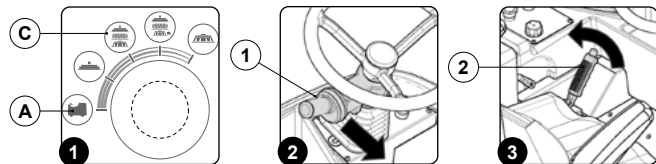

- Select the i-drive program "scrubbing with drying" by rotating the knob to position "C" as shown in (Fig.1).
 - N.B.:** rotating the i-drive selector to the scrubbing with drying program, all the brush heads and squeegee body will move to their working positions (in contact with the floor).
- Press the drive pedal (3) to move both the squeegee body and the brush head bodies to their working positions (Fig.4).
 - N.B.:** on the screen of the command display, the machine silhouette will have a green icon. the symbol that identifies the traction motor; the symbols that identify the motors of the scrubbing brush head; the symbols that identify the motor of the sweeping brush head; the symbols that identify the vacuum motors.
- As soon as the brush head and splash guard bars are in the working position, make sure the machine is in a safe condition (read "MACHINE SAFETY").
 - CAUTION:** these operations must be carried out using protective gloves to avoid any possible contact with the edges or tips of metal objects.
- Stand on the right side of the machine.
- Remove the retainer (4) from the pin (5) in the squeegee body (Fig.5).
- Free the pin (5) in the squeegee body from the eyelet (6) in the squeegee control bar (7) (Fig.6).
- Turn the right splash guard bar (7) as far as it will go.

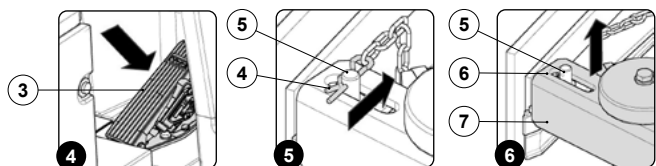

- Using the handle (8) in the debris hopper take out the brush head pre-assembly, remembering to pull down the retainer (9) before pulling the brush head out of the machine (Fig.7).
- Using the handles (8) on the side of the debris hopper, take it to a suitable place and clean it.
- Clean the inside of the debris hopper with a stream of running water, using a brush to remove any dirt residues if necessary.
- Take out the debris hopper vacuum filter (10) (Fig.8), clean it with a jet of water, if necessary use a scraper to remove any residues of dirt.

16. Repeat the operations in reverse order to reassemble all the parts.

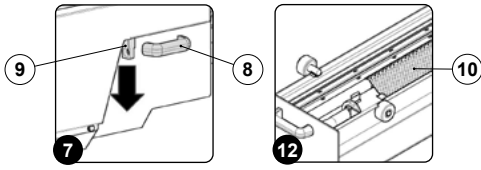

CLEANING THE DISC BRUSHES

Careful cleaning of the disc brush guarantees better cleaning of the floor as well as a longer brush motor life. To clean the disc brush, proceed as follows:

1. Select the i-drive program "transport" by rotating the knob to position "A" as shown in (Fig.1).

i **N.B.:** by rotating the i-drive selector to the transfer program, all the brush heads and the squeegee body will move to their idle positions (raised off floor).

i **N.B.:** on the screen of the command display, the machine silhouette will have a green icon only the symbol that identifies the traction motor.

2. Take the machine to the maintenance area.

♻️ **NOTE:** the place designated for this operation must comply with current environmental protection regulations.

3. Engage the parking brake by moving the parking brake lever (2) (at the side of the operator seat) in the direction shown by the arrow (Fig.2).

i **N.B.:** the symbol regarding the parking brake being engaged will appear on the command display.

4. Select the "scrubbing" program (E) (Fig.3), turn the i-drive adjustment switch (3) in the direction indicated by the arrow (Fig.4).

5. Press the drive pedal (4) to bring the scrubbing brush heads to the working position (Fig.5).

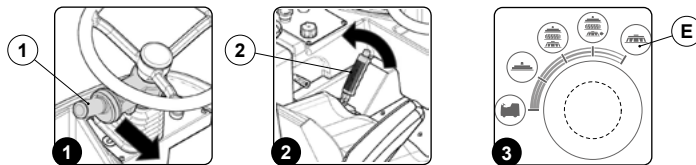

i **N.B.:** on the command display the symbols for the traction motor and the disc brushes motors will be green.

6. As soon as the scrubbing brush heads are in the working position, make sure the machine is in a safe condition (read "MACHINE SAFETY").

7. Remove the right brush head, unscrew the knobs (5) and shift them outward (Fig.6).

8. Place the brush head body on the ground with the brush holding plates in view (Fig.7).

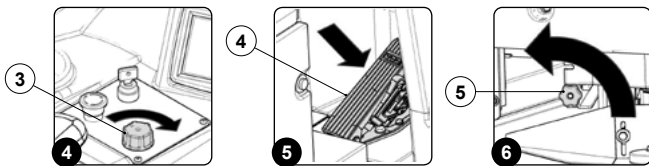

9. Turn until the brush so that the button is pushed towards the outside of the coupling spring.

i **N.B.:** the photo (Fig.8) shows the rotation directions for removing the right scrubbing brush head brushes, for the left brush the rotation direction is the opposite.

10. Clean the brushes under a jet of water and remove any dirt in the brush bristles. Check the bristles. If they are excessively worn, replace the brushes (the bristles should protrude by at least 10mm). Read the paragraph "REPLACING DISC BRUSHES" for replacing the brushes.

11. Repeat the operations in reverse order to reassemble all the parts.

i **N.B.:** you are advised to invert the right and left-hand brushes every day. If the brushes are not new however, and have deformed bristles, it is better to reassemble them in the same position (the right-hand one on the right, and the left-hand one on the left), to prevent the different inclination of the bristles producing an overload on the brush motor as well as excessive vibrations.

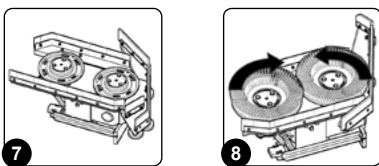

CLEANING CYLINDRICAL BRUSH

Careful cleaning of the cylindrical brush guarantees better cleaning of the floor as well as a longer life for the brush motor.

To clean the cylindrical brush, proceed as follows:

1. Select the i-drive program "transport" by rotating the knob to position "A" as shown in (Fig.1).

i **N.B.:** by rotating the i-drive selector to the transfer program, all the brush heads and the squeegee body will move to their idle positions (raised off floor).

i **N.B.:** on the screen of the command display, the machine silhouette will have a green icon only the symbol that identifies the traction motor.

2. Take the machine to the maintenance area.

♻️ **NOTE:** the place designated for this operation must comply with current environmental protection regulations.

3. Shift the direction lever (1) to "idle", moving it in the direction shown by the arrow (Fig.2).

i **N.B.:** to select idle (N) move the lever in the direction shown by the arrow (Fig.2).

i **N.B.:** the letter "N" will appear on the command display indicating that no gear is engaged.

4. Engage the parking brake by moving the parking brake lever (2), beside the operator's seat, in the direction shown by the arrow (Fig.3).

i **N.B.:** the symbol for the parking brake being engaged will appear on the command display.

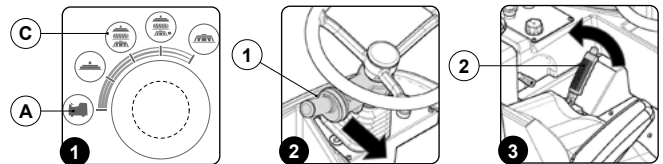

5. Select the i-drive program "scrubbing with drying" by rotating the knob to position "C" as shown in (Fig.1).

i **N.B.:** rotating the i-drive selector to the scrubbing with drying program, all the brush heads and squeegee body will move to their working positions (in contact with the floor).

6. Press the drive pedal (3) to move both the squeegee body and the brush head bodies to their working positions (Fig.4).

i **N.B.:** on the screen of the command display, the machine silhouette will have a green icon. the symbol that identifies the traction motor; the symbols that identify the motors of the scrubbing brush head; the symbols that identify the motor of the sweeping brush head; the symbols that identify the vacuum motors.

7. As soon as the brush head and splash guard bars are in the working position, make sure the machine is in a safe condition (read "MACHINE SAFETY").

⚠️ **CAUTION:** these operations must be carried out using protective gloves to avoid any possible contact with the edges or tips of metal objects.

8. Stand on the right side of the machine.

9. Remove the retainer (4) from the pin (5) in the squeegee body (Fig.5).

10. Free the pin (5) in the squeegee body from the eyelet (6) in the squeegee control bar (Fig.6).

11. Turn the right splash guard bar (7) as far as it will go.

12. Remove the casing cover of the cylindrical control brush arm (8), to do this you first need to remove

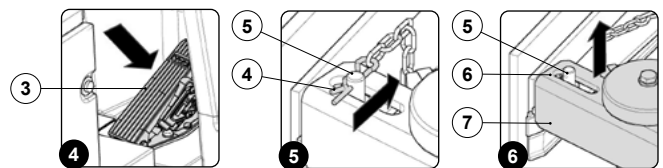

the retainer knobs (9) from the machine. To remove the knobs (9) turn them in the direction shown by the arrow (Fig.7).

13. Remove the cylindrical control brush arm (10), to do this you first need to remove the retainer knob (11). To remove the knob (11) turn it in the direction shown by the arrow (Fig.8).

14. Extract the brush from the machine.

15. Clean the brush under a stream of running water to remove any impurities from its bristles. Check that the bristles are not worn; in the event of excessive wear, replace the brush (the bristles should be at least 10 mm long).

i **ATTENTION:** for replacing the cylindrical brush, read the section "REPLACING THE CYLINDRICAL BRUSH".

16. Insert the new brush in the brush head tunnel, making sure that the pins (12) in the traction hub (13) enter the slots (14) in the brush (Fig.9).

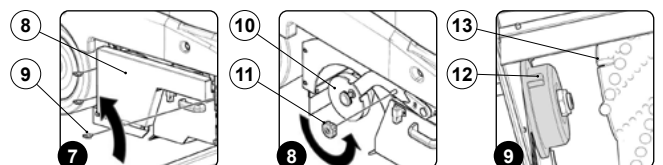

ATTENTION: the brush has been correctly mounted if when seen from above the cusp shape, formed by the bristles, has its top towards the traction wheel (Fig.10).

17. Insert the pipe hub (15) in the cylindrical brush control arm (Fig.11), making sure that the pins (16) in the pipe hub go into the slots (17) in the brush (Fig.11).
18. Repeat the operations in reverse order to reassemble all the parts.

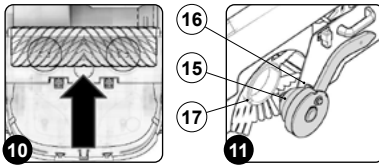

CLEANING THE RECOVERY TANK FILTER

Careful cleaning of the recovery tank filter guarantees a better dirty water vacuuming capacity as well as a longer life of the vacuum motor.

For cleaning the recovery tank filter, proceed as follows:

1. Select the i-drive program "transport" by rotating the knob to position "A" as shown in (Fig.1).

ATTENTION: by rotating the i-drive selector to the transfer program, all the brush heads and the squeegee body will move to their idle positions (raised off floor).

ATTENTION: on the screen of the command display, the machine silhouette will have a green icon only the symbol that identifies the traction motor.

2. Take the machine to the maintenance area.

ATTENTION: the place designated for this operation must comply with current environmental protection regulations.

3. Make sure the machine is in a safe condition (see "MACHINE SAFETY MEASURES").

CAUTION: users are advised to always wear protective gloves, to avoid the risk of serious injury to hands.

4. Release the vacuum lid retainer hinges (1) on the side of the tank (Fig.2).
5. Rotate the vacuum cover (2) until the retainer is in the maintenance position (Fig.3).
6. Remove the recovery tank filter (3) from its seat (Fig.4), clean it under running water, and if necessary use a scraper to remove any waste residues.

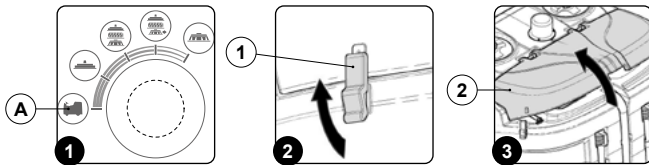

7. Clean the part of the vacuum cover indicated in the figure with a damp cloth (Fig.5).
8. Repeat the operations in reverse order to reassemble all the parts.

ATTENTION: if necessary use the inspection footboard(4) on the back of the machine (Fig.6).

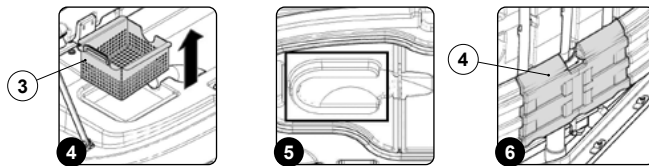

CLEANING THE VACUUM MOTOR FILTER

Careful cleaning of the vacuum motor filter guarantees a better dirty water vacuuming capacity as well as a longer vacuum motor life.

To clean the vacuum motor filter, proceed as follows:

1. Select the i-drive program "transport" by rotating the knob to position "A" as shown in (Fig.1).

ATTENTION: by rotating the i-drive selector to the transfer program, all the brush heads and the squeegee body will move to their idle positions (raised off floor).

ATTENTION: on the screen of the command display, the machine silhouette will have a green icon only the symbol that identifies the traction motor.

2. Take the machine to the maintenance area.

ATTENTION: the place designated for this operation must comply with current environmental protection regulations.

3. Make sure the machine is in a safe condition (see "MACHINE SAFETY MEASURES").

CAUTION: users are advised to always wear protective gloves, to avoid the risk of serious injury to hands.

4. Release the vacuum lid retainer hinges (1) on the side of the tank (Fig.2).
5. Rotate the vacuum cover (2) until the retainer is in the working position (Fig.3).

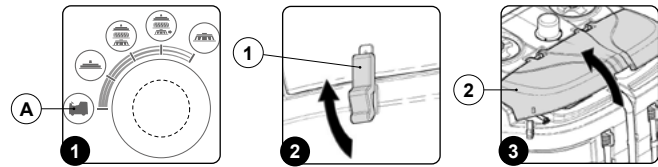

6. Turning anticlockwise, remove the knobs (3) fixing the vacuum motor filter retainer (4) to the vacuum cover (Fig.4).
7. Remove the vacuum motor filter retainer (4) and as a consequence the vacuum motor filter (5) (Fig.5).
8. Clean the filter with a vacuum filter, if necessary remove any impurities with a blast of air, keeping a distance of more than twenty centimetres.
9. Repeat the operations in reverse order to reassemble all the parts.

ATTENTION: if necessary use the inspection footboard (6) on the back of the machine (Fig.6).

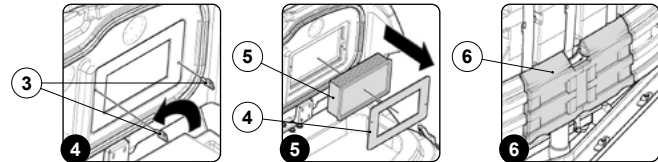

EMPTYING THE SOLUTION TANK

Proceed as follows to empty the solution tank:

1. Select the i-drive program "transport" by rotating the knob to position "A" as shown in (Fig.1).

ATTENTION: by rotating the i-drive selector to the transfer program, all the brush heads and the squeegee body will move to their idle positions (raised off floor).

ATTENTION: on the screen of the command display, the machine silhouette will have a green icon only the symbol that identifies the traction motor.

2. Take the machine to the maintenance area.

ATTENTION: the place designated for this operation must comply with current environmental protection regulations.

3. Make sure the machine is in a safe condition (see "MACHINE SAFETY MEASURES").

CAUTION: users are advised to always wear protective gloves, to avoid the risk of serious injury to hands.

4. Remove the solution tank caps (1) (Fig.2).
5. Uncouple the recovery tank inspection footboard (2) (Fig.3).

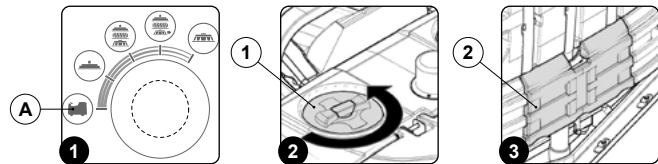

6. Release the solution tank drainage tube (3), at the back of the machine, from the retainers (Fig.4).
7. Bend the end of the drainage tube, so as to create a choke and prevent the content from coming out (Fig.5), put the tube on the discharge surface and gradually release the tube.

ATTENTION: the place designated for this operation must comply with current environmental protection regulations.

8. Repeat the operations in reverse order to reassemble all the parts.

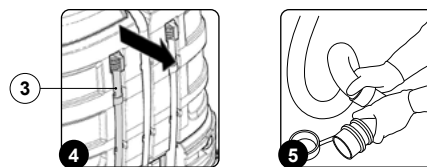

CLEANING THE RECOVERY TANK

To clean the recovery tank, proceed as follows:

1. Select the i-drive program "transport" by rotating the knob to position "A" as shown in (Fig.1).

ATTENTION: by rotating the i-drive selector to the transfer program, all the brush heads and the squeegee body will move to their idle positions (raised off floor).

ATTENTION: on the screen of the command display, the machine silhouette will have a green icon only the symbol that identifies the traction motor.

2. Take the machine to the maintenance area.

ATTENTION: the place designated for this operation must comply with current environmental protection regulations.

3. Make sure the machine is in a safe condition (see "MACHINE SAFETY MEASURES").

CAUTION: users are advised to always wear protective gloves, to avoid the risk of serious injury to hands.

- Release the recovery tank drainage tube (1), at the back of the machine, from the retainers (Fig.2), unscrew the cap and place it on the ground.
- Remove the recovery tank drainage cap (2) (on the back of the machine) and place it on the ground (Fig.3).

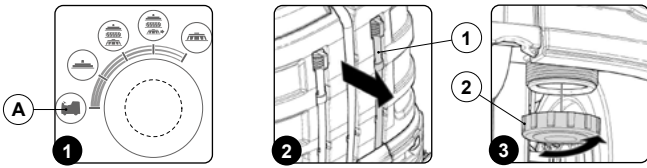

- Release the vacuum lid retainer hinges (3) on the side of the tank (Fig.4).
- Turn the vacuum cover (4) until the retainer (5) is in the work position (Fig.5).
- Rinse the inside with a jet of water, if necessary use a spatula to remove the sludge that has accumulated at the bottom of the tank.
- Take the recovery tank filter (5) out of its seat (Fig.6).

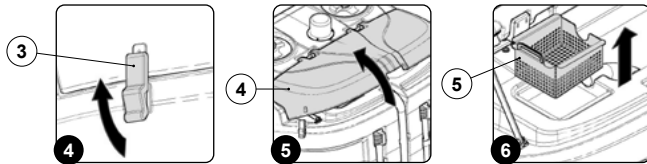

- Carefully rinse the dirty water level float (6) on the inside (Fig.7).
- ATTENTION:** if necessary use the inspection footboard (7) on the back of the machine (Fig.8).
- Repeat the operations in reverse order to reassemble all the parts.

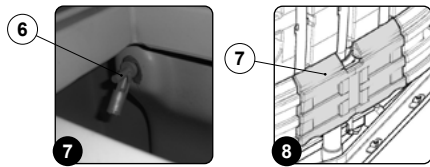

CLEANING THE SOLUTION TANK

Proceed as follows to clean the solution tank:

- Select the i-drive program "transport" by rotating the knob to position "A" as shown in (Fig.1).
- ATTENTION:** by rotating the i-drive selector to the transfer program, all the brush heads and the squeegee body will move to their idle positions (raised off floor).
- ATTENTION:** on the screen of the command display, the machine silhouette will have a green icon only the symbol that identifies the traction motor.
- Take the machine to the maintenance area.
- ATTENTION:** the place designated for this operation must comply with current environmental protection regulations.
- Make sure the machine is in a safe condition (see "MACHINE SAFETY MEASURES").
- CAUTION:** users are advised to always wear protective gloves, to avoid the risk of serious injury to hands.
- Remove the solution tank caps (1) (Fig.2).
- Uncouple the recovery tank inspection footboard (2) (Fig.3).

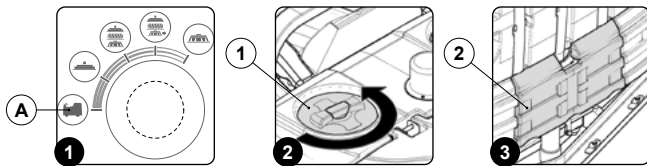

- Release the solution tank drainage tube (3), at the back of the machine, from the retainers (Fig.4). Remove the cap and place it on the ground.
- Rinse the inside with a jet of water, if necessary use a spatula to remove the sludge that has accumulated at the bottom of the tank.
- ATTENTION:** carefully rinse the detergent solution level float (4) inside the tank (Fig.5).
- Repeat the operations in reverse order to reassemble all the parts.

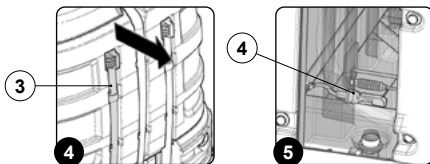

CLEANING THE DETERGENT SOLUTION FILTER

Careful cleaning of the detergent solution filter guarantees better cleaning of the floor. Proceed as follows to clean the detergent solution filter:

- Select the i-drive program "transport" by rotating the knob to position "A" as shown in (Fig.1).
- ATTENTION:** by rotating the i-drive selector to the transfer program, all the brush heads and the squeegee body will move to their idle positions (raised off floor).
- ATTENTION:** on the screen of the command display, the machine silhouette will have a green icon only the symbol that identifies the traction motor.
- Take the machine to the maintenance area.
- ATTENTION:** the place designated for this operation must comply with current environmental protection regulations.
- Make sure the machine is in a safe condition (see "MACHINE SAFETY MEASURES").
- CAUTION:** users are advised to always wear protective gloves, to avoid the risk of serious injury to hands.
- Shut off the detergent solution flow in the machine water system by turning the tap command lever (1) in the direction shown by the arrow (Fig.2).
- Remove the water system filter lid (2) from the front left side of the machine (Fig.3).
- Remove the filter cartridge and clean it under a jet of water, remove any dirt that might be attached.
- Repeat the operations in reverse order to reassemble all the parts.

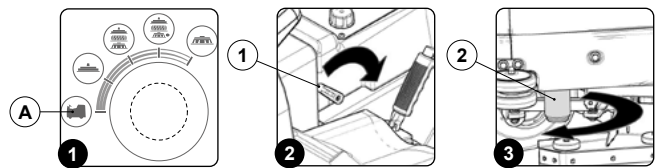

CLEANING THE SQUEEGEE BODY VACUUM TUBE

Careful cleaning of the debris hopper guarantees better drying and cleaning of the floor as well as a longer vacuum motor life. To clean the debris hopper, proceed as follows:

- Select the i-drive program "transport" by rotating the knob to position "A" as shown in (Fig.1).
- ATTENTION:** by rotating the i-drive selector to the transfer program, all the brush heads and the squeegee body will move to their idle positions (raised off floor).
- ATTENTION:** on the screen of the command display, the machine silhouette will have a green icon only the symbol that identifies the traction motor.
- Take the machine to the maintenance area.
- ATTENTION:** the place designated for this operation must comply with current environmental protection regulations.
- Shift the direction lever (1) to "idle", moving it in the direction shown by the arrow (Fig.2).
- ATTENTION:** to select idle (N) move the lever in the direction shown by the arrow (Fig.2).
- ATTENTION:** the letter "N" will appear on the command display indicating that no gear is engaged.
- Engage the parking brake by moving the parking brake lever (2), beside the operator's seat, in the direction shown by the arrow (Fig.3).
- ATTENTION:** the symbol regarding the parking brake being engaged will appear on the command display.

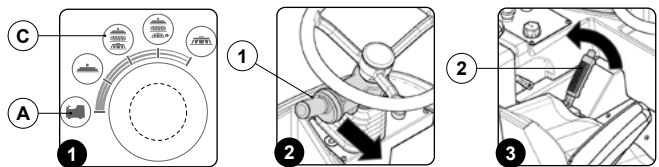

- Select the i-drive program "scrubbing with drying" by rotating the knob to position "C" as shown in (Fig.1).
- ATTENTION:** rotating the i-drive selector to the scrubbing with drying program, all the brush heads and squeegee body will move to their working positions (in contact with the floor).
- Press the drive pedal (3) to move both the squeegee body and the brush head bodies to their working positions (Fig.4).
- ATTENTION:** on the screen of the command display, the machine silhouette will have a green icon: the symbol that identifies the traction motor; the symbols that identify the motors of the scrubbing brush head; the symbols that identify the motor of the sweeping brush head; the symbols that identify the vacuum motors.
- As soon as the brush head and splash guard bars are in the working position, make sure the machine is in a safe condition (read "MACHINE SAFETY").

CAUTION: these operations must be carried out using protective gloves to avoid any possible contact with the edges or tips of metal objects.

- Stand on the right side of the machine.
- Remove the retainer (4) from the pin (5) in the squeegee body (Fig.5).
- Free the pin (5) in the squeegee body from the eyelet (6) in the squeegee control bar (Fig.6).
- Turn the right splash guard bar as far as it will go.

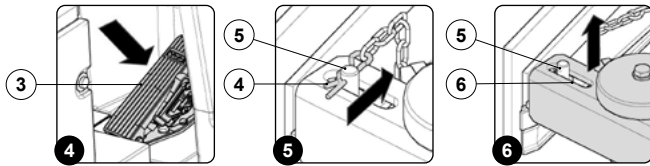

- Using the handle (7) in the debris hopper take out the brush head pre-assembly, remembering to pull down the retainer (8) before pulling the brush head out of the machine (Fig.7).
- Remove the vacuum tube (9) from the nozzle in the squeegee body (Fig.8).
- Remove the vacuum tube (9) from the hole in the recovery tank (Fig.9).
- Clean the inside with a jet of water, inserting the tube in the part of the vacuum nozzle that was fixed to the recovery tank.
- Repeat the operations in reverse order to reassemble all the parts.

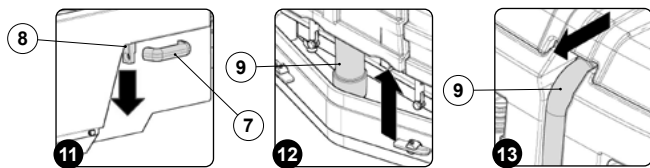

CLEANING THE SCRUBBING BRUSH HEAD SPLASH GUARD

Careful cleaning of the side splash guard rubbers of the scrubbing brush head guarantees better cleaning of the floor.

To clean the side splash guard rubbers of the scrubbing brush head, proceed as follows:

- Select the i-drive program "transport" by rotating the knob to position "A" as shown in (Fig.1).

ATTENTION: by rotating the i-drive selector to the transfer program, all the brush heads and the squeegee body will move to their idle positions (raised off floor).

ATTENTION: on the screen of the command display, the machine silhouette will have a green icon only the symbol that identifies the traction motor.

- Take the machine to the maintenance area.

ATTENTION: the place designated for this operation must comply with current environmental protection regulations.

- Make sure the machine is in a safe condition (see "MACHINE SAFETY MEASURES").

CAUTION: users are advised to always wear protective gloves, to avoid the risk of serious injury to hands.

- Stand on the right side of the machine and clean the lateral splash guard rubber (1) of the scrubbing brush head body (Fig.2) with a damp cloth.
- Repeat the operation also for the left scrubbing brush head body.

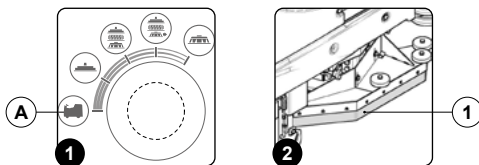

CLEANING SQUEEGEE SPLASH GUARD BARS RUBBER

Careful cleaning of the splash guard rubbers of the squeegee body guarantees better cleaning of the floor.

To clean the splash guard rubbers of the squeegee body, do as follows:

- Select the i-drive program "transport" by rotating the knob to position "A" as shown in (Fig.1).

ATTENTION: by rotating the i-drive selector to the transfer program, all the brush heads and the squeegee body will move to their idle positions (raised off floor).

ATTENTION: on the screen of the command display, the machine silhouette will have a green icon only the symbol that identifies the traction motor.

- Take the machine to the maintenance area.

ATTENTION: the place designated for this operation must comply with current environmental protection regulations.

- Make sure the machine is in a safe condition (see "MACHINE SAFETY MEASURES").

CAUTION: users are advised to always wear protective gloves, to avoid the risk of serious injury to hands.

- Stand on the right side of the machine and clean the squeegee splash guard bar rubber (1) of the scrubbing brush head body (Fig.2) with a damp cloth.
- Repeat the operation also for the left scrubbing brush head body.

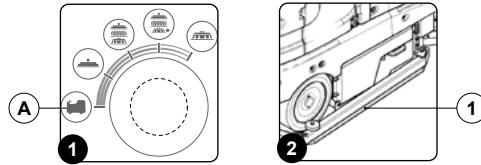

CLEANING THE DETERGENT TANK (VERSIONS WITH CDS)

Careful cleaning of the detergent canister guarantees better efficiency of the machine water system, and therefore better efficiency when cleaning the floor. To clean the detergent canister, proceed as follows:

- Bring the machine to the area designated for refilling the solution tank.
- Make sure the machine is in a safe condition (read "MACHINE SAFETY").

CAUTION: protective gloves should always be worn before handling detergents or acidic or alkaline solutions, to avoid serious injury to the hands.

- Open the detergent canister hatch (1) on the back right of the machine (Fig.1).
- Disconnect the male insert (2) from the female insert (3) in the cap (4) of the detergent canister (5) (Fig.2).

ATTENTION: before pulling on the male insert, push the lever on the female insert.

- Remove the detergent canister (5) from the solution tank compartment (Fig.3).
- Remove the cap (4) of the detergent canister (Fig.4).
- Remove any detergent residue.
- Rinse the inside of the canister with a jet of running water.
- Repeat the operations in reverse order to reassemble all the parts.

ATTENTION: the place designated for this operation must comply with current environmental protection regulations.

ATTENTION: be sure to respect current environmental protection regulations, and never discharge the detergent directly into the drain.

ATTENTION: fill with clean water, at a temperature no greater than 50°C and no less than 10°C.

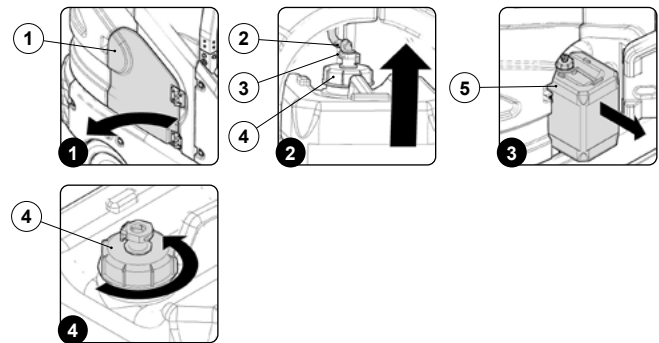

CLEANING THE WATER SYSTEM

If the machine is to be left unused for a long time, perform the following tasks:

- Bring the machine to the maintenance area.
- Shift the direction lever (1) to "idle", moving it in the direction shown by the arrow (Fig.1).

ATTENTION: to select idle (N) move the lever in the direction shown by the arrow (Fig.1).

ATTENTION: the letter "N" will appear on the command display indicating that no gear is engaged.

- Engage the parking brake by moving the parking brake lever (2) (at the side of the operator seat) in the direction shown by the arrow (Fig.2).

ATTENTION: the symbol for the parking brake being engaged will appear on the command display.

- Check the water tap is fully open, the lever (3) must be turned completely clockwise (Fig.3).
- Turn the main machine switch (4) to "I", turning the key (5) a quarter turn to the right (Fig.4).

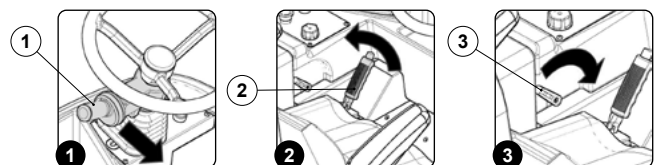

- Select the i-drive program "scrubbing with drying" by rotating the knob to position "C" as shown in (Fig.5).

ATTENTION: rotating the i-drive selector to the scrubbing with drying program, all the brush heads and squeegee body will move to their working positions (in contact with the floor).

7. When the work screen appears in the command display, press the button (6) for the "STD" working program (Fig.6).

ATTENTION: the grey symbols identify the components that are not active, the green symbols identify the components that are active.

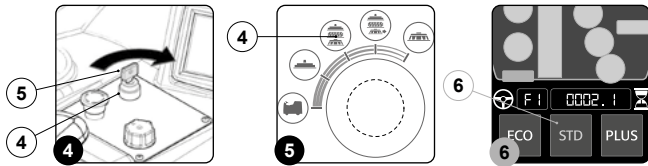

8. Press the button (7) for adjusting the detergent solution flow (Fig.7).

ATTENTION: pressing the button (7) makes the buttons (+) and (-) visible.

ATTENTION: pressing the button (+) increases the solution supplied, pressing the button (-) decreases the solution supplied. Every time the buttons (+) or (-) are pressed the button symbol (7) changes.

9. Set the maximum amount of detergent solution, pressing the (+) button until the symbol is full.

10. Press the drive pedal (8) to start the brush head and the dosing system (Fig.8).

ATTENTION: as soon as you press the drive pedal (8), the brush heads and the squeegee body will move down until they are in contact with the floor, and will start working. At the same time, the solenoid valve and dosing system will start dispensing the detergent solution.

11. Wait a few minutes, normally 2 – 4 minutes, to allow the dosing system to be washed.

ATTENTION: the machine will dispense solution during this operation.

12. Completely empty the solution tank and the detergent canister (read the paragraph titled "EMPTYING THE SOLUTION TANK" and the paragraph "CLEANING THE DETERGENT CANISTER (only for versions with CDS)").

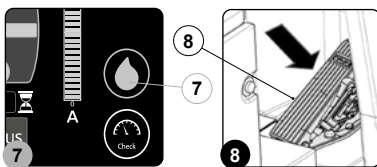

CLEANING THE WATER SYSTEM (VERSIONS WITH CDS)

If the machine is to be left unused for a long time, perform the following tasks:

1. Bring the machine to the area designated for refilling the solution tank.
2. Make sure the machine is in a safe condition (read "MACHINE SAFETY").

CAUTION: protective gloves should always be worn before handling detergents or acidic or alkaline solutions, to avoid serious injury to the hands.

3. Open the detergent canister hatch (1) on the back right of the machine (Fig.1).
4. Disconnect the male insert (2) from the female insert (3) in the cap (4) of the detergent canister (5) (Fig.2).

ATTENTION: before pulling on the male insert, push the lever on the female insert.

5. Remove the detergent canister (5) from the solution tank compartment (Fig.3).
6. Remove the cap (4) of the detergent canister (Fig.4).
7. Fill the canister with water.

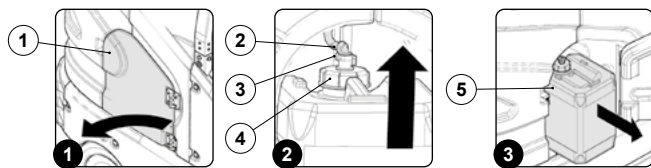

ATTENTION: the place designated for this operation must comply with current environmental protection regulations.

ATTENTION: be sure to respect current environmental protection regulations, and never discharge the detergent directly into the drain.

ATTENTION: fill with clean water, at a temperature no greater than 50°C and no less than 10°C.

8. Make sure you tighten the cap (4) properly to avoid any liquid leaks when working (Fig.5). Also make sure that the detergent intake filter (6) is correctly positioned on the bottom of the canister (Fig.6).

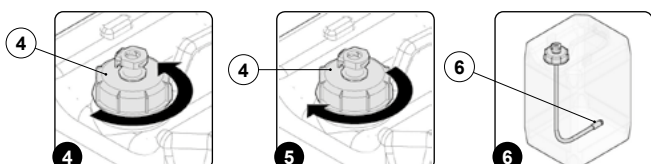

9. Put back the detergent canister (5) in the compartment in the solution tank (Fig.7).
10. Connect the male insert (2) to the female insert (3) in the cap (4) of the detergent canister (5) (Fig.8).

11. Close the chemical detergent canister hatch.
12. Shift the direction lever (6) to "idle", moving it in the direction shown by the arrow (Fig.9).

ATTENTION: to select idle (N) move the lever in the direction shown by the arrow (Fig.9).

ATTENTION: the letter "N" will appear on the command display indicating that no gear is engaged.

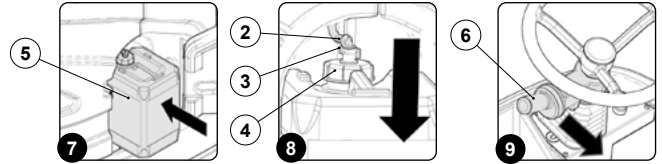

13. Engage the parking brake by moving the parking brake lever (7), beside of the operator's seat, in the direction shown by the arrow (Fig.10).

ATTENTION: the symbol for the parking brake being engaged will appear on the command display.

14. Check the water tap is fully open, the lever (8) must be turned completely clockwise (Fig.11).

15. Turn the main machine switch (9) to "I", turning the key (10) a quarter turn to the right (Fig.12).

16. Select the i-drive program "scrubbing with drying" by rotating the knob to position "C" as shown in (Fig.13).

ATTENTION: rotating the i-drive selector to the scrubbing with drying program, all the brush heads and squeegee body will move to their working positions (in contact with the floor).

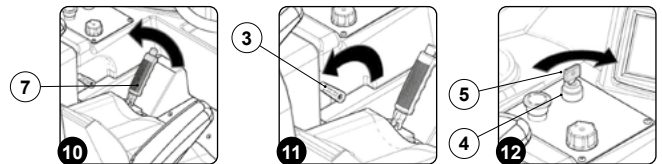

17. When the work screen appears on the command display, press the "STD" working program button (11) (Fig.14).

ATTENTION: the grey symbols identify the components that are not active, the green symbols identify the components that are active.

18. Press the button (12) for regulating the detergent solution flow (Fig.15).

ATTENTION: pressing the button (12) makes the (+) and (-) buttons visible.

ATTENTION: pressing the button (+) increases the solution supplied, pressing the button (-) decreases the solution supplied. Every time the buttons (+) or (-) are pressed the button symbol (12) changes.

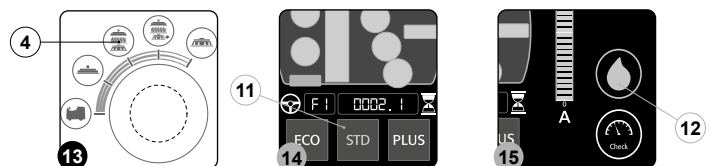

19. Set the maximum amount of detergent solution, pressing the (+) button until the symbol is full.

20. Press the drive pedal (13) to start the brush head and the dosing system (Fig.16).

ATTENTION: as soon as you press the drive pedal (13), the brush head and squeegee body will move down until they are in contact with the floor, and will start working. At the same time, the solenoid valve and dosing system will start dispensing the detergent solution.

21. Wait a few minutes, normally 2 – 4 minutes, to allow the dosing system to be washed.

ATTENTION: the machine will dispense solution during this operation.

22. Completely empty the solution tank and the detergent canister (read the paragraph titled "EMPTYING THE SOLUTION TANK" and the paragraph "CLEANING THE DETERGENT CANISTER (only for versions with CDS)").

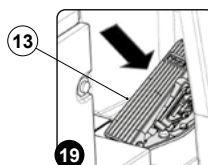

EXTRAORDINARY MAINTENANCE WORK

ASSEMBLING THE SQUEEGEE BODY

To mount it the squeegee body on the machine, do as follows:

- Bring the machine to the maintenance area.
- Shift the direction lever (1) to "idle", moving it in the direction shown by the arrow (Fig.1).
- Engage the parking brake by moving the parking brake lever (2) (at the side of the operator seat) in the direction shown by the arrow (Fig.2).
- Select the "drying" program (B) (Fig.3), turn the switch for adjusting the i-drive (3) in the direction shown by the arrow (Fig.4).
- Press the drive pedal (4) to bring the squeegee body to the working position (Fig.5).

i N.B.: to select idle (N) move the lever in the direction shown by the arrow (Fig.1).

i N.B.: the letter "N" will appear on the command display indicating that no gear is engaged.

i N.B.: the symbol regarding the parking brake being engaged will appear on the command display.

i N.B.: in the command display the symbols for the traction motor and the vacuum motors are shown in green.

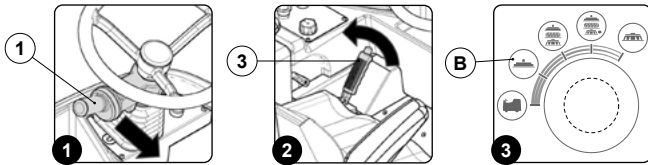

i N.B.: in the command display the symbols for the traction motor and the vacuum motors are shown in green.

- As soon as the squeegee body has reached the working position, carry out the procedures for securing the machine (see the section "SECURING THE MACHINE").
- Using the relevant equipment loosen the screws (5) and (6) in the squeegee body pre-assembly (Fig.6).

w N.B.: the equipment to be used for this operation is not supplied with the machine.

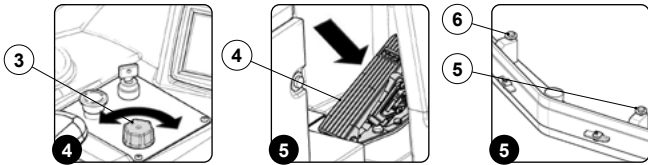

- Insert the screw (5) in the squeegee body into the slot (7) in the squeegee support (Fig.7), making sure that the washer (8) adheres to the top of the squeegee support.
- Repeat the operation also for the left screw (6).
- Using the relevant equipment loosen the screws (5) and (6) in the squeegee body pre-assembly (Fig.8).

w N.B.: the equipment to be used for this operation is not supplied with the machine.

- Insert the pin (9) in the squeegee body into the slot (10) on the splash guard bar (Fig.9).
- Insert the pin seal (11) into the hole on the pin (9) of the squeegee body (Fig.10).

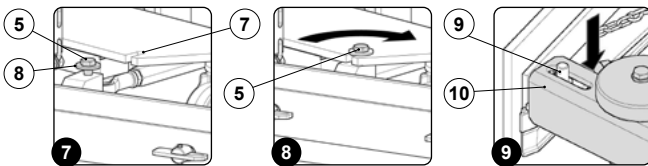

i N.B.: the operation just described is valid for the right pin, repeat the operations just described also for the left pin.

- Insert the vacuum tube (12) into the sleeve in the squeegee body (Fig.11).

i NB: the squeegee has already been adjusted, but refer to "ADJUSTING THE SQUEEGEE BODY RUBBER BLADES" if you need any information.

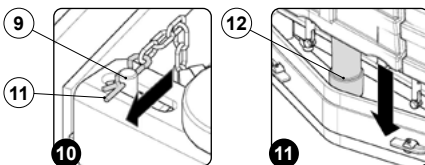

FITTING DISC BRUSHES

Careful cleaning of the disc brush into the brush holder plate guarantees better cleaning of the floor as well as a longer life of the brush motor.

To insert the brush correctly, do as follows:

- Bring the machine to the maintenance area.
- Shift the direction lever (1) to "idle", moving it in the direction shown by the arrow (Fig.1).
- Engage the parking brake by moving the parking brake lever (2) (at the side of the operator seat) in the direction shown by the arrow (Fig.2).
- Select the "scrubbing" program (E) (Fig.3), turn the i-drive adjustment switch (3) in the direction indicated by the arrow (Fig.4).

i N.B.: To select idle (N) move the lever in the direction shown by the arrow, if for example gear F is engaged (Fig.1).

i N.B.: the letter "N" will appear on the command display indicating that no gear is engaged.

i N.B.: the symbol regarding the parking brake being engaged will appear on the command display.

i N.B.: on the command display the symbols for the traction motor and the disc brushes motors will be green.

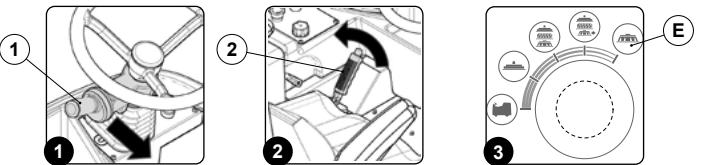

- Press the drive pedal (4) to bring the scrubbing brush heads to the working position (Fig.5).

i N.B.: on the command display the symbols for the traction motor and the disc brushes motors will be green.

- As soon as the scrubbing brush heads are in the working position, make sure the machine is in a safe condition (read "MACHINE SAFETY").
- Remove the right brush head, unscrew the knobs (5) and shift them outward (Fig.6).

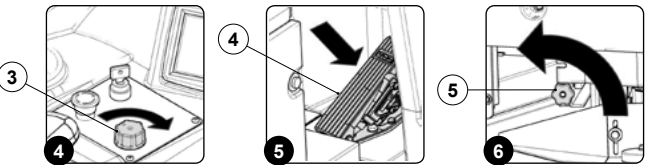

- Place the brush head body on the ground with the brush holding plates in view (Fig.7).
- Insert the brush in its seat on the brush-holder plate, turning it until the three buttons enter the slots on the plate. Turn until the pin is pushed towards the coupling spring and is locked into place.

i N.B.: the photo (Fig.8) shows the rotation directions for coupling the right scrubbing brush head, for the left one the direction of rotation is the opposite.

- Repeat the operations in reverse order to refit everything.

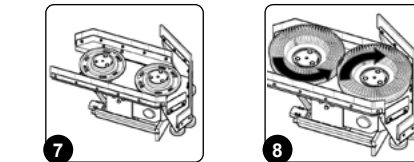

FITTING THE CYLINDRICAL BRUSH

Careful cleaning of the cylindrical brush in the sweeping brush head body provides better cleaning of the floor as well as a longer life of the brush motor.

To insert the cylindrical brush correctly, do as follows:

- Select the i-drive program "transport" by rotating the knob to position (A*) as shown in (Fig.1).
- Take the machine to the maintenance area.
- Shift the direction lever (1) to "idle", moving it in the direction shown by the arrow (Fig.2).
- Engage the parking brake by moving the parking brake lever (2), beside the operator's seat, in the direction shown by the arrow (Fig.3).

i N.B.: by rotating the i-drive selector to the transfer program, all the brush heads and the squeegee body will move to their idle positions (raised off floor).

i N.B.: on the screen of the command display, the machine silhouette will have a green icon only the symbol that identifies the traction motor.

- Take the machine to the maintenance area.

♻️ NOTE: the place designated for this operation must comply with current environmental protection regulations.

- Shift the direction lever (1) to "idle", moving it in the direction shown by the arrow (Fig.2).

i N.B.: to select idle (N) move the lever in the direction shown by the arrow, if for example gear F is engaged (Fig.2).

i N.B.: the letter "N" will appear on the command display indicating that no gear is engaged.

- Engage the parking brake by moving the parking brake lever (2), beside the operator's seat, in the direction shown by the arrow (Fig.3).

i N.B.: the symbol regarding the parking brake being engaged will appear on the command display.

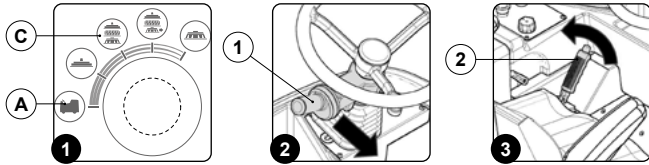

5. Select the i-drive program "scrubbing with drying" by rotating the knob to position (C) as shown in (Fig.1).

i **N.B.:** rotating the i-drive selector to the scrubbing with drying program, all the brush heads and squeegee body will move to their working positions (in contact with the floor).

6. Press the drive pedal (3) to move both the squeegee body and the brush head bodies to their working positions (Fig.4).

i **N.B.:** on the screen of the command display, the machine silhouette will have a green icon: the symbol that identifies the traction motor; the symbols that identify the motors of the scrubbing brush head; the symbols that identify the motor of the sweeping brush head; the symbols that identify the vacuum motors.

7. As soon as the brush head and splash guard bars are in the working position, make sure the machine is in a safe condition (read "[MACHINE SAFETY](#)").

! **CAUTION:** these operations must be carried out using protective gloves to avoid any possible contact with the edges or tips of metal objects.

8. Stand on the right side of the machine.

9. Remove the retainer (4) from the pin (5) in the squeegee body (Fig.5).

10. Free the pin (5) in the squeegee body from the eyelet (6) in the squeegee control bar (Fig.6).

11. Turn the right splash guard bar (7) as far as it will go.

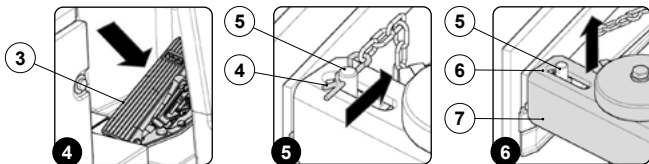

12. Remove the casing cover of the cylindrical control brush arm (8), to do this you first need to remove the retainer knobs (9) from the machine. To remove the knobs (9) turn them in the direction shown by the arrow (Fig.7).

13. Remove the cylindrical control brush arm (10), to do this you first need to remove the retainer knob (11). To remove the knob (11) turn it in the direction shown by the arrow (Fig.8).

14. Insert the brush in the brush head tunnel, making sure that the pins (12) in the traction hub enter the slots (13) in the brush (Fig.9).

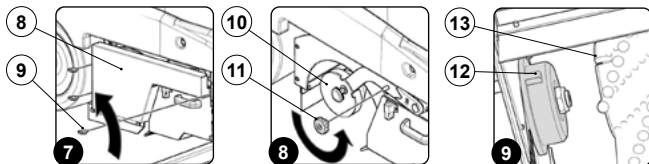

! **ATTENTION:** the brush has been correctly mounted if when seen from above the cusp shape, formed by the bristles, has its top towards the traction wheel (Fig.10).

15. Insert the pipe hub in the cylindrical brush control arm in the brush body, making sure that the pins (14) in the pipe hub go into the slots (15) in the brush (Fig.11).

16. Fix the cylindrical brush control arm to the guide bar using the retainer knob (16) (Fig.12).

17. Repeat the operations in reverse order to reassemble all the parts.

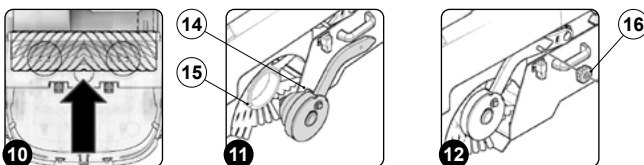

FITTING THE ROLL BAR

For packaging reasons, the roll bar comes disassembled from the machine. In order to fit it to the machine chassis, do the following:

1. Bring the machine to the maintenance area.

2. Make sure the machine is in a safe condition (read "[MACHINE SAFETY](#)").

3. Grip the handle (1) and raise the seat mounting plate to the maintenance position (Fig.1).

4. Grip the handle (2) and lift the battery inspection carter (3) (Fig.2), turn the carter until the safety catches (4) are engaged (Fig.3).

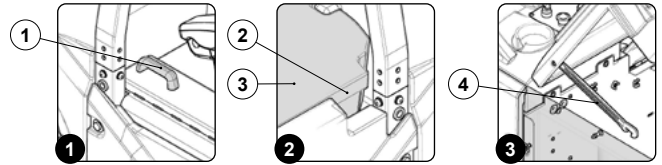

5. Insert the pins (5) in the roll bar in the slots (64) in the machine chassis (Fig.4).

i **N.B.:** it is recommended that the operation just described be carried out by at least two people.

6. Fix the roll bar to the chassis with the nuts and bolts (7), remember to insert also the hole cover cap (8) (Fig.5).

! **N.B.:** the equipment to be used for this operation is not supplied with the machine.

REPLACING THE DISC BRUSHES

To replace the disc brush, proceed as follows:

1. Select the i-drive program "transport" by rotating the knob to position "A" as shown in (Fig.1).

i **N.B.:** by rotating the i-drive selector to the transfer program, all the brush heads and the squeegee body will move to their idle positions (raised off floor).

i **N.B.:** on the screen of the command display, the machine silhouette will have a green icon only the symbol that identifies the traction motor.

2. Take the machine to the maintenance area.

! **NOTE:** the place designated for this operation must comply with current environmental protection regulations.

3. Engage the parking brake by moving the parking brake lever (2) (at the side of the operator seat) in the direction shown by the arrow (Fig.2).

i **N.B.:** the symbol regarding the parking brake being engaged will appear on the command display.

4. Select the "scrubbing" program (E) (Fig.3), turn the i-drive adjustment switch (3) in the direction indicated by the arrow (Fig.4).

5. Press the drive pedal (4) to bring the scrubbing brush heads to the working position (Fig.5).

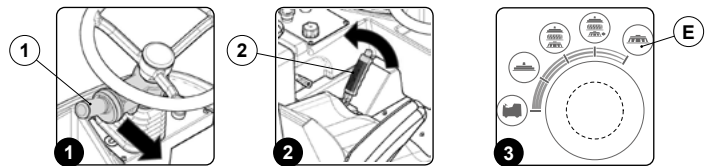

i **N.B.:** on the command display the symbols for the traction motor and the disc brushes motors will be green.

6. As soon as the scrubbing brush heads are in the working position, make sure the machine is in a safe condition (read "[MACHINE SAFETY](#)").

7. Remove the right brush head, unscrew the knobs (5) and shift them outward (Fig.6).

8. Place the brush head body on the ground with the brush holding plates in view (Fig.7).

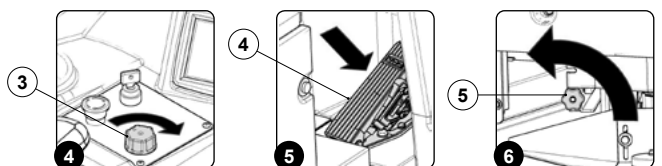

9. Turn until the brush so that the button is pushed towards the outside of the coupling spring.

i **N.B.:** the photo (Fig.8) shows the rotation directions for removing the right scrubbing brush head brushes, for the left brush the rotation direction is the opposite.

10. Replace the worn brushes, read the paragraph "[REPLACING THE DISC BRUSHES](#)" for replacing the brushes.

11. Repeat the operations in reverse order to reassemble all the parts.

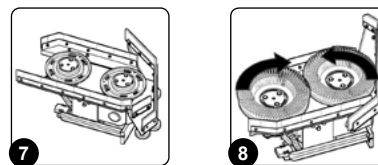

REPLACING THE CYLINDRICAL BRUSH

To clean the cylindrical brush, proceed as follows:

- Select the i-drive program "transport" by rotating the knob to position "A" as shown in (Fig.1).
 - N.B.:** by rotating the i-drive selector to the transfer program, all the brush heads and the squeegee body will move to their idle positions (raised off floor).
 - N.B.:** on the screen of the command display, the machine silhouette will have a green icon only the symbol that identifies the traction motor.
- Take the machine to the maintenance area.
 - NOTE:** the place designated for this operation must comply with current environmental protection regulations.
- Shift the direction lever (1) to "idle", moving it in the direction shown by the arrow (Fig.2).
 - N.B.:** to select idle (N) move the lever in the direction shown by the arrow (Fig.2).
 - N.B.:** the letter "N" will appear on the command display indicating that no gear is engaged.
- Engage the parking brake by moving the parking brake lever (2), beside the operator's seat, in the direction shown by the arrow (Fig.3).
 - N.B.:** the symbol for the parking brake being engaged will appear on the command display.
- Select the i-drive program "scrubbing with drying" by rotating the knob to position "C" as shown in (Fig.1).

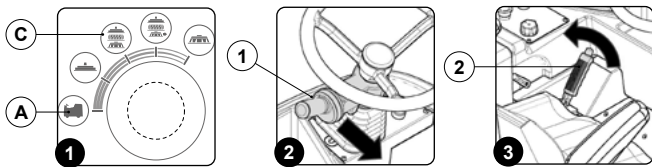

- rotating the i-drive selector to the scrubbing with drying program, all the brush heads and squeegee body will move to their working positions (in contact with the floor).
 - N.B.:** on the screen of the command display, the machine silhouette will have a green icon: the symbol that identifies the traction motor; the symbols that identify the motors of the scrubbing brush head; the symbols that identify the motor of the sweeping brush head; the symbols that identify the vacuum motors.
- As soon as the brush head and splash guard bars are in the working position, make sure the machine is in a safe condition (read "MACHINE SAFETY").
 - CAUTION:** these operations must be carried out using protective gloves to avoid any possible contact with the edges or tips of metal objects.
- Stand on the right side of the machine.
- Remove the retainer (4) from the pin (5) in the squeegee body (Fig.5).
- Free the pin (5) in the squeegee body from the eyelet (6) in the squeegee control bar (Fig.6).
- Turn the right splash guard bar (7) as far as it will go.

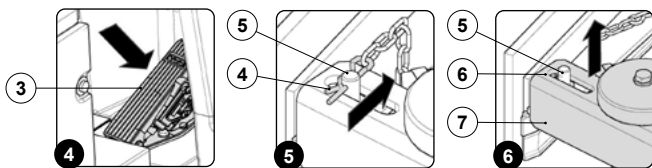

- Remove the casing cover of the cylindrical control brush arm (8), to do this you first need to remove the retainer knobs (9) from the machine. To remove the knobs (9) turn them in the direction shown by the arrow (Fig.7).
- Remove the cylindrical control brush arm (10), to do this you first need to remove the retainer knob (11). To remove the knob (11) turn it in the direction shown by the arrow (Fig.8).
- Extract the brush from the machine.
- About replacing the worn brush, read the section "FITTING THE CYLINDRICAL BRUSH" for replacing the brushes.
- Insert the new brush in the brush head tunnel, making sure that the pins (12) in the traction hub (13) enter the slots (14) in the brush (Fig.9).

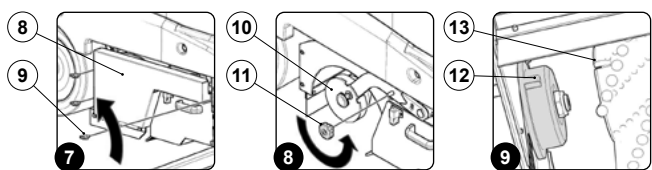

- N.B.:** the brush has been correctly mounted if when seen from above the cusp shape, formed by the bristles, has its top towards the traction wheel (Fig.10).
- Insert the pipe hub (15) in the cylindrical brush control arm (Fig.11), making sure that the pins (16) in the pipe hub go into the slots (17) in the brush (Fig.11).
 - Repeat the operations in reverse order to reassemble all the parts.

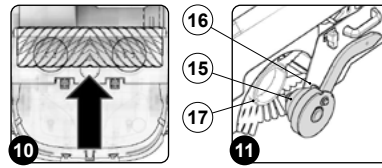

REPLACING THE SQUEEGEE BODY RUBBER BLADES

The good condition of the squeegee rubber blades guarantees better cleaning and drying of the floor, as well as a longer vacuum motor life. To replace the squeegee rubber blades, proceed as follows:

- Select the i-drive program "transport" by rotating the knob to position "A" as shown in (Fig.1).
 - N.B.:** by rotating the i-drive selector to the transfer program, all the brush heads and the squeegee body will move to their idle positions (raised off floor).
 - N.B.:** on the screen of the command display, the machine silhouette will have a green icon only the symbol that identifies the traction motor.
- Take the machine to the maintenance area.
 - NOTE:** the place designated for this operation must comply with current environmental protection regulations.
- Shift the direction lever (1) to "idle", moving it in the direction shown by the arrow (Fig.2).
 - N.B.:** to select idle (N) move the lever in the direction shown by the arrow (Fig.2).
 - N.B.:** the letter "N" will appear on the command display indicating that no gear is engaged.
- Engage the parking brake by moving the parking brake lever (2), beside the operator's seat, in the direction shown by the arrow (Fig.3).
 - N.B.:** the symbol regarding the parking brake being engaged will appear on the command display.

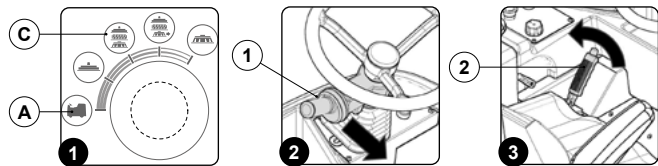

- Select the i-drive program "scrubbing with drying" by rotating the knob to position "C" as shown in (Fig.1).
 - N.B.:** rotating the i-drive selector to the scrubbing with drying program, all the brush heads and squeegee body will move to their working positions (in contact with the floor).
- Press the drive pedal (3) to move both the squeegee body and the brush head bodies to their working positions (Fig.4).
 - N.B.:** on the screen of the command display, the machine silhouette will have a green icon: the symbol that identifies the traction motor; the symbols that identify the motors of the scrubbing brush head; the symbols that identify the motor of the sweeping brush head; the symbols that identify the vacuum motors.
- As soon as the brush head and splash guard bars are in the working position, make sure the machine is in a safe condition (read "MACHINE SAFETY").
 - CAUTION:** these operations must be carried out using protective gloves to avoid any possible contact with the edges or tips of metal objects.
- Stand on the right side of the machine.
- Remove the retainer (4) from the pin (5) in the squeegee body (Fig.5).
- Free the pin (5) in the squeegee body from the eyelet (6) in the squeegee control bar (Fig.6).
- Repeat steps nine and ten on the left-hand side of the machine.

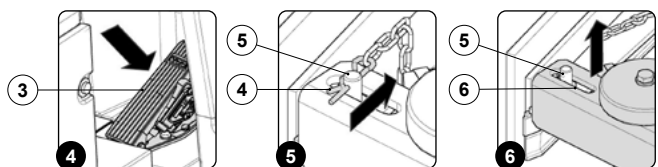

- Loosen the screws (7) fixing the squeegee (Fig.7).
 - N.B.:** the equipment to be used for this operation is not supplied with the machine.
- Use the appropriate tool to remove the screws (8) that fix the front rubber-pressing blade (9) to the squeegee body (Fig.8).

N.B.: the equipment to be used for this operation is not supplied with the machine.

14. Remove the front rubber-pressing blade (9) (Fig.9).
15. Remove the front rubber blade (10) and replace it (Fig.10).

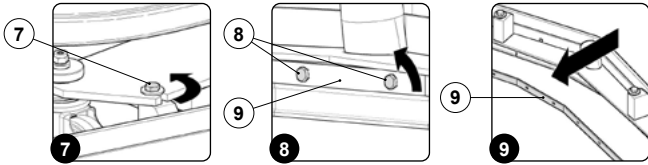

16. To fix the front rubber-pressing blade to the squeegee body, follow the instructions in reverse order.
17. Use the appropriate tool to rotate the retainers blades (11) that fix the rear rubber-pressing blade (12) to the squeegee body (Fig.11).

N.B.: the equipment to be used for this operation is not supplied with the machine.

18. Remove the rear rubber-pressing blade (13) (Fig.12).
19. Remove the rear rubber blade (14) and replace it (Fig.17).

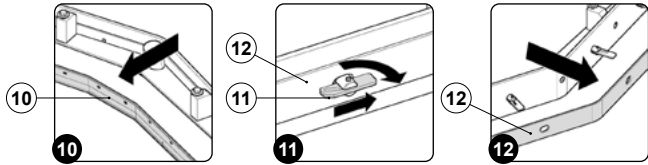

20. To fix the rear rubber-pressing blade to the squeegee body, follow the instructions in reverse order.
21. Repeat the operations in reverse order to reassemble all the parts.

ATTENTION: before using the machine, remember to adjust the squeegee body. Read ["ADJUSTING THE SQUEEGEE BODY RUBBER BLADES"](#).

ATTENTION: it is good practice to replace both squeegee blades, to ensure good results when drying the floor.

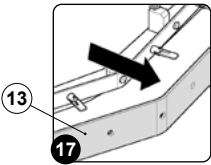

REPLACING THE SQUEEGEE SPLASH GUARD BARS RUBBER

Ensuring the good condition of the squeegee body's splash guard bar guarantees better floor cleaning and drying results, as well as a longer service life for the vacuum motor. To replace the squeegee body's splash guard bar rubber do as follows:

1. Select the i-drive program "transport" by rotating the knob to position "A" as shown in (Fig.1).

N.B.: by rotating the i-drive selector to the transfer program, all the brush heads and the squeegee body will move to their idle positions (raised off floor).

N.B.: on the screen of the command display, the machine silhouette will have a green icon only the symbol that identifies the traction motor.

2. Take the machine to the maintenance area.

NOTE: the place designated for this operation must comply with current environmental protection regulations.

3. As soon as the machine has reached the maintenance area, make sure it is in a safe condition (read ["MACHINE SAFETY"](#)).

CAUTION: these operations must be carried out using protective gloves to avoid any possible contact with the edges or tips of metal objects.

4. Stand on the right side of the machine.
5. Remove the retainer (1) from the pin (2) in the squeegee body (Fig.2).
6. Free the pin (2) in the squeegee body from the slot (3) in the squeegee control bar (4) (Fig.3).
7. Turn the right splash guard bar (4) as far as it will go.
8. Use the appropriate tool to remove the screws (5) that fix the rubber-pressing blade (6) to the splash guard bar (Fig.5).

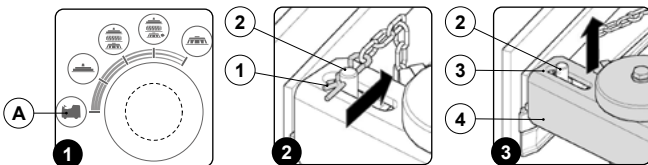

N.B.: the equipment to be used for this operation is not supplied with the machine.

9. Remove the rubber-pressing blade (6) (Fig.6).

10. Remove the splash guard rubber (7) and replace it (Fig.7).
11. Repeat the operations in reverse order to reassemble all the parts.
12. Repeat steps 5 - 11 also for the left-hand side of the machine.

ATTENTION: before using the machine remember to adjust the squeegee body splash guard bar rubber, read the section ["ADJUSTING THE SQUEEGEE BODY SPLASH GUARD BAR RUBBER"](#).

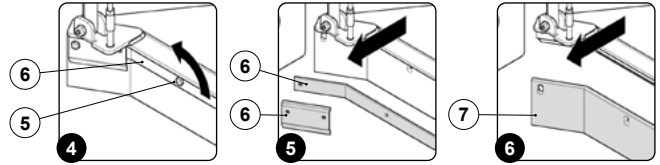

REPLACING THE SCRUBBING BRUSH HEAD SPLASH GUARD RUBBER

The good condition of the splash guard rubber of the scrubbing brush head guarantees better cleaning of the floor.

To replace the splash guard rubber of the scrubbing brush head, proceed as follows:

1. Select the i-drive program "transport" by rotating the knob to position "A" as shown in (Fig.1).

N.B.: by rotating the i-drive selector to the transfer program, all the brush heads and the squeegee body will move to their idle positions (raised off floor).

N.B.: on the screen of the command display, the machine silhouette will have a green icon only the symbol that identifies the traction motor.

2. Take the machine to the maintenance area.

NOTE: the place designated for this operation must comply with current environmental protection regulations.

3. As soon as the machine has reached the maintenance area, make sure it is in a safe condition (read ["MACHINE SAFETY"](#)).

CAUTION: these operations must be carried out using protective gloves to avoid any possible contact with the edges or tips of metal objects.

4. Stand on the right side of the machine.
5. Using a suitable tool remove the screws (1) fixing the scrubbing brush head splash guard support (2) (Fig.2).

N.B.: the equipment to be used for this operation is not supplied with the machine.

6. Remove the scrubbing brush head splash guard support from the machine.
7. Use the appropriate tool to remove the screws (3) that fix the rubber-pressing blade (4) to the scrubbing brush head splash guard support (Fig.3).

N.B.: the equipment to be used for this operation is not supplied with the machine.

8. Remove the rubber-pressing blade (4) (Fig.4).
9. Remove the splash guard rubber (5) and replace it (Fig.5).

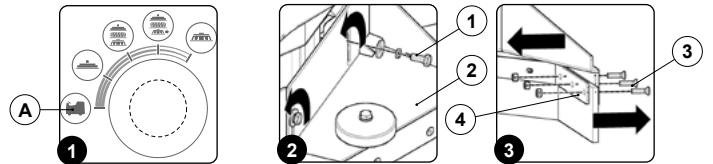

10. Repeat the operations in reverse order to reassemble all the parts.
11. Repeat steps 4 - 11 on the left-hand side of the machine.

ATTENTION: before using the machine remember to adjust the squeegee body splash guard bar rubber, read the section ["ADJUSTING THE BRUSH HEAD SPLASH GUARD RUBBER"](#).

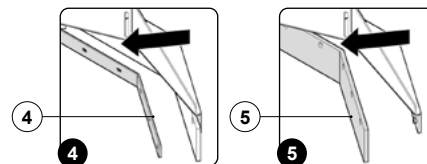

ADJUSTMENT INTERVENTIONS

ADJUSTING THE SCRUBBING BRUSH HEAD SPLASH GUARD RUBBER

Careful cleaning of the side splash guard rubbers of the scrubbing brush head guarantees better cleaning of the floor.

To replace the splash guard rubber of the scrubbing brush head, proceed as follows:

- Select the i-drive program "transport" by rotating the knob to position "A" as shown in (Fig.1).
 - N.B.:** by rotating the i-drive selector to the transfer program, all the brush heads and the squeegee body will move to their idle positions (raised off floor).
 - N.B.:** on the screen of the command display, the machine silhouette will have a green icon only the symbol that identifies the traction motor.
- Take the machine to the maintenance area.
 - NOTE:** the place designated for this operation must comply with current environmental protection regulations.
- Shift the direction lever (1) to "idle", moving it in the direction shown by the arrow (Fig.2).
 - N.B.:** to select idle (N) move the lever in the direction shown by the arrow (Fig.2).
 - N.B.:** the letter "N" will appear on the command display indicating that no gear is engaged.
- Engage the parking brake by moving the parking brake lever (2), beside the operator's seat, in the direction shown by the arrow (Fig.3).
 - N.B.:** the symbol regarding the parking brake being engaged will appear on the command display.
- Select the i-drive program "scrubbing with drying" by rotating the knob to position "C" as shown in (Fig.1).

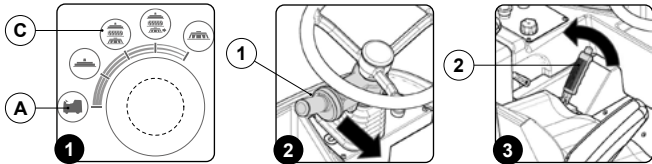

- N.B.:** rotating the i-drive selector to the scrubbing with drying program, all the brush heads and squeegee body will move to their working positions (in contact with the floor).
- Press the drive pedal (3) to move both the squeegee body and the brush head bodies to their working positions (Fig.4).
 - N.B.:** on the screen of the command display, the machine silhouette will have a green icon: the symbol that identifies the traction motor; the symbols that identify the motors of the scrubbing brush head; the symbols that identify the motor of the sweeping brush head; the symbols that identify the vacuum motors.
- As soon as the brush head and splash guard bars are in the working position, make sure the machine is in a safe condition (read "[MACHINE SAFETY](#)").
 - CAUTION:** these operations must be carried out using protective gloves to avoid any possible contact with the edges or tips of metal objects.
- Stand on the right side of the machine.
- Using a suitable tool loosen the screws (4) that fix the scrubbing brush head splash guard support (5) to the scrubbing brush head body (Fig.5).
 - N.B.:** the equipment to be used for this operation is not supplied with the machine.
- Move up or down (Fig.6) the scrubbing brush head splash guard support until the splash guard rubber is evenly folded outwards along its length by about 30°- 45° with respect to the floor (Fig.7).

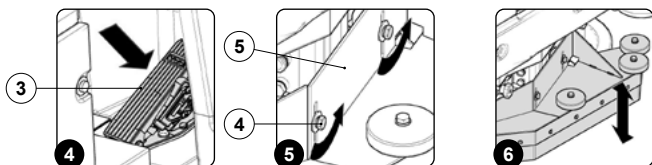

- As soon as the adjustment of the splash guard rubber is finished, using suitable equipment tighten the screws (4) that fix the scrubbing brush head splash guard support (5) to the scrubbing brush head body (Fig.8).
 - N.B.:** the equipment to be used for this operation is not supplied with the machine.
- Repeat steps 9 - 11 also for the left-hand side of the machine.

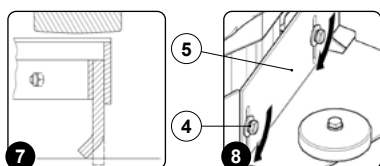

ADJUSTING THE SQUEEGEE SPLASH GUARD BAR RUBBER

Careful cleaning of the splash guard rubber of the squeegee body guarantees better cleaning of the floor. To adjust the squeegee lateral splash guard rubber, proceed as follows:

- Select the i-drive program "transport" by rotating the knob to position "A" as shown in (Fig.1).
 - N.B.:** by rotating the i-drive selector to the transfer program, all the brush heads and the squeegee body will move to their idle positions (raised off floor).
 - N.B.:** on the screen of the command display, the machine silhouette will have a green icon only the symbol that identifies the traction motor.
- Take the machine to the maintenance area.
 - NOTE:** the place designated for this operation must comply with current environmental protection regulations.
- Shift the direction lever (1) to "idle", moving it in the direction shown by the arrow (Fig.2).
 - N.B.:** to select idle (N) move the lever in the direction shown by the arrow (Fig.2).
 - N.B.:** the letter "N" will appear on the command display indicating that no gear is engaged.
- Engage the parking brake by moving the parking brake lever (2), beside the operator's seat, in the direction shown by the arrow (Fig.3).
 - N.B.:** the symbol regarding the parking brake being engaged will appear on the command display.
- Select the i-drive program "scrubbing with drying" by rotating the knob to position "C" as shown in (Fig.1).
 - N.B.:** rotating the i-drive selector to the scrubbing with drying program, all the brush heads and squeegee body will move to their working positions (in contact with the floor).

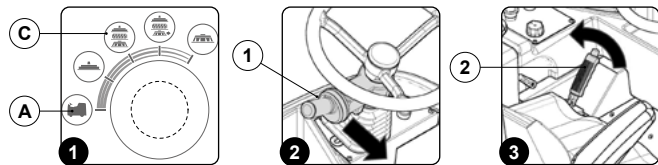

- Press the drive pedal (3) to move both the squeegee body and the brush head bodies to their working positions (Fig.4).
 - N.B.:** on the screen of the command display, the machine silhouette will have a green icon: the symbol that identifies the traction motor; the symbols that identify the motors of the scrubbing brush head; the symbols that identify the motor of the sweeping brush head; the symbols that identify the vacuum motors.
- As soon as the brush head and splash guard bars are in the working position, make sure the machine is in a safe condition (read "[MACHINE SAFETY](#)").
 - CAUTION:** these operations must be carried out using protective gloves to avoid any possible contact with the edges or tips of metal objects.
- Stand on the right side of the machine.
- Using the specific tool loosen the nut (4) locking the adjustment pin (5) to the splash guard bar body (6) (Fig.5).
 - N.B.:** the equipment to be used for this operation is not supplied with the machine.
- To adjust the front part of the splash guard rubber, turn the adjustment pin (5) until the splash guard rubber is evenly folded outwards along the entire length by about 30°- 45° with respect to the floor (Fig.6).
- Remove the retainer (7) from the pin (8) in the squeegee body (Fig.7).
- Free the pin (8) in the squeegee body from the slot (9) in the squeegee control bar (Fig.8).
- To adjust the rear part of the splash guard rubber, using the specific tool screw in or unscrew the nut (10) until the splash guard rubber is evenly folded outwards along the entire length by about 30°- 45° with respect to the floor (Fig.9).

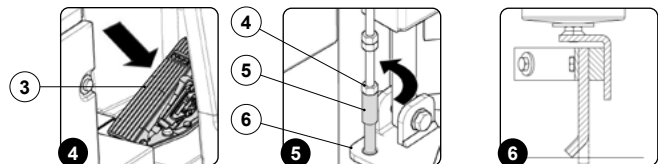

- N.B.:** the equipment to be used for this operation is not supplied with the machine.
 - N.B.:** to check that the rear part of the splash guard rubber has been adjusted correctly you need to reposition the splash guard bar body above the squeegee body.
- Repeat steps 9 - 13 also for the left-hand side of the machine.

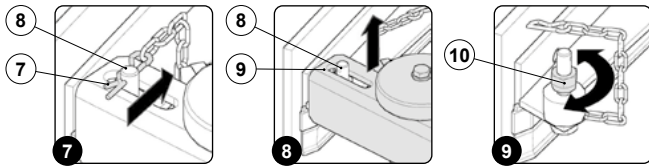

ADJUSTING THE SQUEEGEE BODY RUBBER BLADES

Careful adjustment of the squeegee body rubber blades guarantees better cleaning of the floor. To adjust the squeegee body blades, proceed as follows:

1. Select the i-drive program "transport" by rotating the knob to position "A" as shown in (Fig.1).

N.B.: by rotating the i-drive selector to the transport program, all the brush heads and the squeegee body will move to their idle positions (raised off floor).

N.B.: on the screen of the command display, the machine silhouette will have a green icon only the symbol that identifies the traction motor.

2. Take the machine to the maintenance area.

NOTE: the place designated for this operation must comply with current environmental protection regulations.

3. Shift the direction lever (1) to "idle", moving it in the direction shown by the arrow (Fig.2).

N.B.: to select idle (N) move the lever in the direction shown by the arrow (Fig.2).

N.B.: the letter "N" will appear on the command display indicating that no gear is engaged.

4. Engage the parking brake by moving the parking brake lever (2), beside the operator's seat, in the direction shown by the arrow (Fig.3).

N.B.: the symbol regarding the parking brake being engaged will appear on the command display.

5. Select the i-drive program "scrubbing with drying" by rotating the knob to position "C" as shown in (Fig.1).

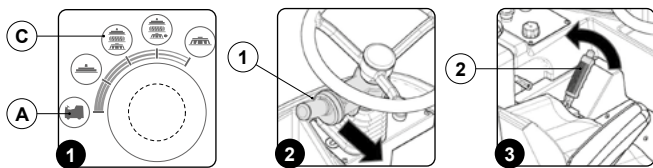

N.B.: rotating the i-drive selector to the scrubbing with drying program, all the brush heads and squeegee body will move to their working positions (in contact with the floor).

6. Press the drive pedal (3) to move both the squeegee body and the brush head bodies to their working positions (Fig.4).

N.B.: on the screen of the command display, the machine silhouette will have a green icon: the symbol that identifies the traction motor; the symbols that identify the motors of the scrubbing brush head; the symbols that identify the motor of the sweeping brush head; the symbols that identify the vacuum motors.

7. As soon as the brush head and splash guard bars are in the working position, make sure the machine is in a safe condition (read "MACHINE SAFETY").

CAUTION: these operations must be carried out using protective gloves to avoid any possible contact with the edges or tips of metal objects.

8. Stand at the back of the machine.

9. Use the appropriate tool to loosen the nut (4) that holds the adjustment screw (5) in place (Fig.5).

N.B.: the equipment to be used for this operation is not supplied with the machine.

10. To adjust the central part of the splash guard rubber, turn the adjustment pin (5) until the splash guard rubber is evenly folded outwards along the entire length by about 30°- 45° with respect to the floor (Fig.6).

11. To adjust the outer part of the splash guard rubber, loosen the knob (6) and screw in or unscrew the pin (7) until the splash guard rubber is evenly folded outwards along the entire length by about 30°- 45° with respect to the floor (Fig.7).

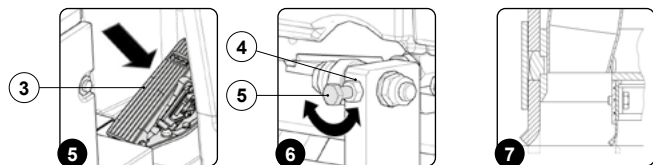

ATTENTION: the right-hand and left-hand knobs must be rotated the same number of times, so that the squeegee is parallel to the floor when it is working.

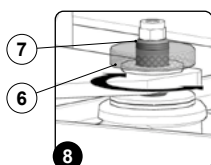

DISPOSAL

To dispose of the machine, take it to a demolition centre or an authorised collection centre. Before scrapping the machine, it is necessary to remove and separate out the following materials, then send them to the appropriate collection centres in accordance with the environmental hygiene regulations currently in force:

- Brushes
- Felt
- Electric and electronic parts*
- Batteries
- Plastic parts (tanks and handlebars)
- Metal parts (levers and frame)

(*) In particular, contact your distributor when scrapping electric and electronic parts.



CHOOSING AND USING THE BRUSHES

POLYPROPYLENE BRUSH (PPL)

Used on all types of floors. Good resistance to wear and tear, and hot water (no greater than 50°C.). The polypropylene is non-hygroscopic and therefore retains its characteristics even when working in wet conditions.

ABRASIVE BRUSH

The bristles of this type of brush are charged with highly aggressive abrasives. It is used to clean very dirty floors. To avoid floor damage, work only with the pressure strictly necessary.

BRISTLE THICKNESS

Thicker bristles are more rigid and are therefore used on smooth floors or floors with small joints.

On uneven floors or those with deep joints, it is advisable to use softer bristles which can enter the gaps more easily.

Remember that when the bristles are worn and therefore too short, they will become rigid and are no longer able to penetrate and clean deep down. In this case, like with over-large bristles, the brush tends to jump.

PAD HOLDER

The pad holder is recommended for cleaning shiny surfaces.

There are two types of pad holder:

1. The traditional pad holder is fitted with a series of anchor points that allow the abrasive floor pad to be held and dragged while working.
2. The CENTRE LOCK type pad holder not only has anchor points, but also a snap-type central locking system in plastic that allows the abrasive floor pad to be perfectly centred and held without any risk of it becoming detached. This type of pad holder is recommended above all for machines with more than one brush, where the centring of the abrasive discs is difficult.

CODE	NO. OF BRUSHES	TYPE OF BRISTLES	Ø BRISTLES	Ø BRUSHES	BRUSH LENGTH	N.B.
404638	4	PPL	1.4	345	-	WHITE DISC BRUSH
404639	4	ABRASIVE	1.5	345	-	DISC BRUSH
405521	4	-	-	345	-	PAD HOLDER WITH CENTRE LOCK
404640	1	PPL	0.7	300	1110	WHITE CYLINDRICAL BRUSH
404642	1	ABRASIVE	0.6	300	1110	CYLINDRICAL BRUSH

EC DECLARATION OF CONFORMITY



The undersigned manufacturer:

COMAC S.p.A.

Via Maestri del Lavoro, 13

37059 Santa Maria di Zevio (VR)

declares under its sole responsibility that the products

FLOOR SCRUBBING MACHINE mod. C130 BF 2015

comply with the provisions of Directives:

- 2006/42/EC: Machinery Directive.
- 2014/30/EC: Electromagnetic compatibility directive.

They also comply with the following standards:

- EN 60335-1: Household and similar electrical appliances - Safety. Part 1: Generic standards.
- EN 60335-2-72: Household and similar electrical appliances. Part 2: Specific standards for automatic machines for floor treatment for commercial and industrial use.
- EN 12100-1: Safety of Machinery - Basic concepts, general principles for design - Part 1: Basic terminology and methodology.
- EN 12100-2: Safety of Machinery - Basic concepts, general principles for design - Part 2: Technical principles.
- EN 61000-6-2: Electromagnetic compatibility (EMC) - Part 6-2: Generic standards - Immunity for industrial environments.
- EN 61000-6-3: Electromagnetic compatibility (EMC) - Part 6-3: Generic standards - Standard emission for residential, commercial and light-industrial environments.
- EN 62233: Household and similar electrical appliances - Electromagnetic fields - Methods for evaluation and measurement.

The person authorized to compile the technical file:

Mr. Giancarlo Ruffo

Via Maestri del Lavoro, 13

37059 Santa Maria di Zevio (VR) - ITALY

Santa Maria di Zevio (VR), 11/01/2016

Comac S.p.A.
Legal representative
Giancarlo Ruffo

TROUBLESHOOTING

This chapter lists the most common problems linked with the use of the machine. If you are unable to resolve the problems with the information given here, please contact your nearest assistance centre.

PROBLEM	POSSIBLE CAUSE	SOLUTION
THE MACHINE DOES NOT START	The main switch is set to "0".	Make sure that the main switch is at "I", if not turn the key a quarter turn to right.
	Generator connector disconnected from the electrical system's connector.	Connect to the generator's connector to the machine's electrical system connector.
	Fuel tank fuel level low.	Perform the refuelling operations (see the section titled REFUELLING).
	LPG cylinder empty.	Replace the LPG cylinder (see the section titled REPLACING THE LPG CYLINDER).
	Starter battery discharged.	Contact your nearest support centre to have the starter battery replaced.
THE MACHINE DOES NOT MOVE	The machine is not on.	Read the section " THE MACHINE DOES NOT START ".
	The parking brake is engaged.	Release the parking brake by means of the brake command lever near the operator's seat.
	There is an issue on the drive pedal.	On the " CHECK SCREEN " check the absorption values of the drive pedal .
	Check that when switched on there are no alarm messages on the command display.	Stop the machine immediately, and contact a specialised service centre.
INSUFFICIENT DETERGENT SOLUTION ON THE BRUSHES	Detergent solution filter obstructed.	Check that the detergent solution filter is not obstructed; if it is, clean it (read " CLEANING THE DETERGENT SOLUTION FILTER ").
	The flow rate of the detergent solution in the machine water system is not right for the work to be carried out.	In the working program being used, check that the detergent solution flow values are suitable for the work to be undertaken, if not select another working program. In the working program being used, check that the detergent solution flow values are suitable for the work to be undertaken, if not temporarily change the detergent solution flow capacity (read the section " TEMPORARY ADJUSTMENT OF THE DETERGENT SOLUTION DELIVERY ").
THE MACHINE DOES NOT CLEAN CORRECTLY	Not enough detergent solution comes out.	Read the section " INSUFFICIENT DETERGENT SOLUTION ON THE BRUSHES ".
	The brushes have not been inserted correctly in the machine.	Check that the disc brushes are correctly inserted in the machine (read " FITTING THE DISC BRUSH "). Make sure the cylindrical brush is correctly inserted in the machine (read " FITTING THE CYLINDRICAL BRUSH ").
	The type of brush used is not suitable for the dirt to be cleaned.	Make sure that the brushes fitted on the machine are suitable for the work to be carried out. Read " CHOOSING AND USING THE BRUSHES ".
	The brush bristles are excessively worn.	Check the condition of the brush, and replace it if necessary (read "" or else REPLACING THE CYLINDRICAL BRUSH).
	The pressure exerted on the brushes is not right for the work to be carried out.	In the working program being used, check that the detergent solution flow values are suitable for the work to be undertaken, if not select another working program. In the working program being used, check that the pressure being exercised on the brush is suitable for the work to be undertaken, if not temporarily change the pressure (read the section " TEMPORARY ADJUSTMENT OF THE PRESSURE ON THE BRUSHES ").
THE SQUEEGEE DOES NOT DRY PERFECTLY	The vacuum unit is obstructed.	Make sure the squeegee is free of obstructions (read " CLEANING THE SQUEEGEE BODY ").
		Make sure the vacuum tube is free of obstructions (read " CLEANING THE SQUEEGEE BODY VACUUM TUBE ").
		Make sure that the vacuum cap filter is free of any obstructions (see the section " CLEANING THE RECOVERY TANK'S FILTER ").
		Make sure that the debris hopper filter is free of any obstructions (see the section " CLEANING THE DEBRIS HOPPER FILTER ").
		Make sure the vacuum motor filter is free of obstructions (read " CLEANING THE VACUUM MOTOR FILTER ").
	The cap on the recovery tank drainage tube is not properly positioned.	Check that the cap on the recovery tank drainage tube is positioned properly.
The recovery tank lid is not positioned correctly.	Check that the recovery tank lid is properly positioned on the machine.	
EXCESSIVE FOAM PRODUCTION	The detergent being used is not suitable.	Check that a low foam detergent has been used. If necessary, add a small quantity of anti-foam liquid to the recovery tank.
THE MACHINE DOES NOT VACUUM CORRECTLY	The recovery tank is full.	Empty the recovery tank (read the section " EMPTYING THE RECOVERY TANK ").
	The vacuum unit is obstructed	Read the section " THE SQUEEGEE DOES NOT DRY PERFECTLY ".

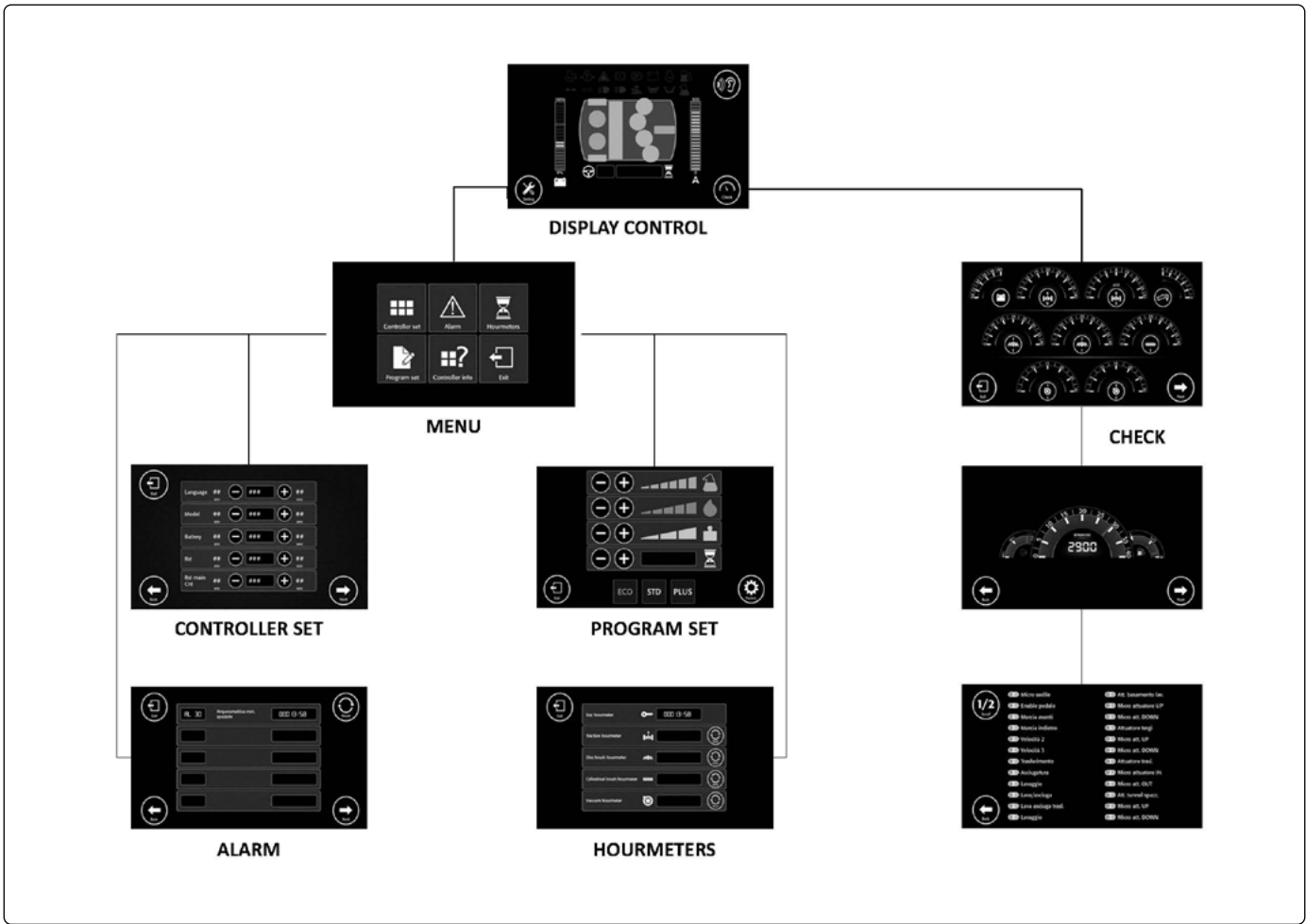

BROWSING THE COMMAND DISPLAY MENU

On the work screen it is possible to display the screens:

1. CHECK: which displays the consumption of all the machine's motors, the voltage of the batteries and the reference of the drive pedal (see the section "CHECK SCREEN").
2. MENU: where you can customise the machine pre-set parameters, the sub-menus that can be edited are:
 - I. CONTROLLER SET: allows you to customise the machine parameters (read the section "CONTROLLER SET").
 - II. ALARM: allows you to display the last twenty-five alarms registered by the machine (see the section "ALARM").
 - III. PROGRAM SET: allows you to modify the parameters of the machine's pre-set programs (read the section "PROGRAM SET").
 - III. HOUR METERS: allows you to display the machine's hour meter (read the section "HOUR METERS").

N.B.: pressing the "EXIT" key returns you to the previous menu screen.

CONTROLLER SET

Pressing the "CONTROLLER SET" button (1) on the "MENU" screen (Fig.1) displays the pop-up of the "PASSWORD" (Fig.2), to access the controller set menu enter the level 2 password.

N.B.: pressing the "ENTER" key (2) the series of digital numbers is confirmed (Fig.2). If you make a mistake entering the password press the button (2) and enter the correct sequence of numbers.

By entering the correct password you access the "CONTROLLER SET" menu (Fig.3), on the following screen it is possible to change the following parameters:

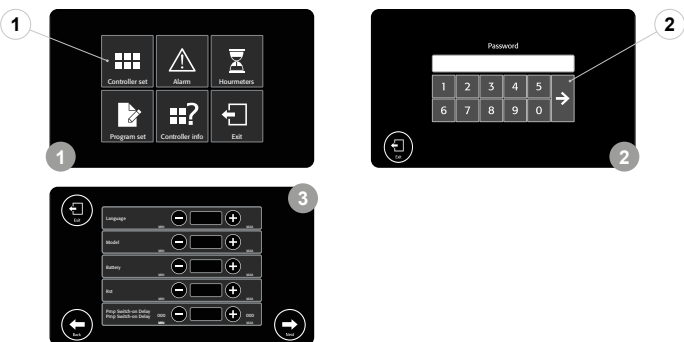

Item ID	Description (EN)	Category	Parameter
3	Language	General	0=EN 1=IT 2=FR 3=DE 4=ES
4	Manual Mode	General	0=NO 1=YES
5	DayLight	General	0=NO 1=YES
9	Battery Type	General	0=WET 1=GEL 2=AGM 3=CUSTOM
24	Partial hour meter count	General	0=key 1=Tr 2=work
25	Display hour meter	General	0=Main 1=Partial
27	Reset partial hour meter	General	0=NO 1=YES
37	Password 2 Site manager	General	1234
38	Password 3 User	General	000
39	Password protection	General	0
40	Service Warning Start	General	0
42	Service Warning Time	General	0
43	Service Count	General	0=key 1=Tr 2=work
120	Chemical level Manual Mode	Chemical	70
151	Vacuum Switch-OFF1 Delay	Vacuum	20
154	Vacuum Speed Reduction	Vacuum	30.0
168	Traction Forward Max Speed	Traction	100
169	Traction Backward Max Speed	Traction	70
171	Traction Mode1 Speed	Traction	60
172	Traction Mode2 Speed	Traction	80

ATTENTION: this list contains theoretical parameters that should be agreed upon with the nearest COMAC specialised technician.

Language: this is the parameter for changing the language of the machine's command display, the languages that can be selected are: EN - IT - FR - DE - ES.
Manual Mode: this is the parameter to enable or disable the possibility of setting the working parameters manually or else to use the three pre-set programs (ECO - STD - PLUS).
DayLight: this is the parameter for deciding whether the blinking lights should be switched on or remain off.

Battery Type: this is the parameter for changing the type of setting for the batteries that are used to power the machine, the following types can be selected: WET - GEL - AGM - CUSTOM.

Partial hour meter count: this is the parameter for adjusting the partial hour meter activation, you can start the counting of the hours starting from: key (from the starting of the general switch key) - Tr (from the starting of the traction motor) - work (from the start of work of the machine).

Display hour meter: this is the parameter for selecting the type of hour meter displayed on the command display, you can select from Main (total) - Partial (partial).

Reset partial hour meter: this is the parameter for resetting the partial hour meter.

Password 2 Site manager: this is the password for changing the level 2 password (supervisor). The factory setting of the password is 1234, it can be changed using a number from 1000 to 1999. The increase of the numbers is unitary.

Password 3 User: this is the password for changing the level 3 password (user). The factory setting of the password is 000, it can be changed using a number from 000 to 999. The increase of the numbers is unitary.

Password protection: this is the password to protect, using a password, certain functions of the machine menu. The factory setting is 0, which is the equivalent of no protection.

Service Warning Start: this is the parameter of activating the first compulsory maintenance, the factory setting is 0, which can be changed using a number from 0 to 1000. The increase of the numbers is decimal, the number identifies the number of hours that have passed.

N.B.: once the value indicated by the parameter (40) has passed the icon "MAINTENANCE DUE" appears on the command display.

Service Warning Time: this is the parameter of activating the first compulsory maintenance, the factory setting is 0, which can be changed using a number from 0 to 1000. The increase of the numbers is decimal, the number identifies the number of hours that have passed.

N.B.: once the value indicated by the parameter (42) has passed the icon "MAINTENANCE DUE" appears on the command display.

Service Count: this is the parameter for adjusting the partial hour meter activation, you can start the counting of the hours starting from: key (from the starting of the general switch key) - Tr (from the starting of the traction motor) - work (from the start of work of the machine).

Chemical level Manual Mode: this is the parameter for changing the chemical percentage in the detergent solution in the machine's water system (versions with CDS), factory set to 70, which can be changed using a number from 0 to 100. The increase of the numbers is unitary, the number identifies the chemical percentage in the detergent solution.

Vacuum Switch-OFF1 Delay: this is the parameter for changing the vacuum motors switching off delay time, factory set to 20, which can be changed using a number from 1 to 600. The increase of the numbers is unitary, the number identifies the delay in seconds of the switching off of the vacuum motors.

Vacuum Speed Reduction: this is the parameter for changing the electric potential in "NOISE REDUCTION" mode, factory set to 30,0 which can be changed using a number from 20.0 to 36.0. The increase of the numbers is unitary, the number identifies the electric potential of the vacuum motors in noise reduction mode.

Traction Forward Max Speed: this is the parameter for changing the maximum forward moving speed, factory set to 100, which can be changed using a number from 50 to 100. The increase of the numbers is by two units, the number identifies the percentage of the maximum speed of the hub motor.

Traction Backward Max Speed: this is the parameter for changing the maximum reverse speed, factory set to 70, which can be changed using a number from 10 to 100. The increase of the numbers is by two units, the number identifies the percentage of the maximum speed of the hub motor.

Traction Mode1 Speed: this is the parameter for changing the step-01 speed, factory set to 60, which can be changed using a number from 10 to 100. The increase of the numbers is by two units, the number identifies the percentage of the maximum speed set.

Traction Mode2 Speed: this is the parameter for changing the step-02 speed, factory set to 80, which can be changed using a number from 10 to 100. The increase of the numbers is by two units, the number identifies the percentage of the maximum speed set.

HOUR METERS

Pressing the "HOUR METERS" button accesses the machine's hour meter screen (Fig.6), it is possible to display the hour meter in it:

1. Main key switch hour meter, it starts with activation in position "I" of the key in the main switch.
2. Traction motor hour meter, it starts when the traction motor starts.
3. Scrubbing brush heads brush motors hour meter, it starts when the brush motors in the scrubbing brush head start.
4. Sweeping brush head brush motor hour meter, it starts when the brush motor in the sweeping brush head starts.
5. Vacuum motor hour meter, it starts when the vacuum motors start.



ALARM

Pressing the "ALARM" button gives you access to the alarm screen (Fig.4), where it is possible to display the last twenty-five alarms registered by the machine.



PROGRAM SET

Pressing the "PROGRAM SET" button gives you access to the screen for changing the work programs (Fig.5), changing the machine's pre-set working programs read the section "[CHANGING WORKING PROGRAM PARAMETERS](#)".

N.B.: the factory setting is that those with level 2 password and those with level 3 password can both freely access this screen, setting parameter 3 with value 1 activates the password entry to access the above-mentioned menu.

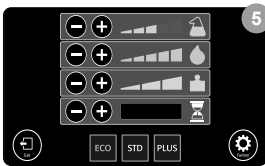



COMAC S.p.A. - Via Maestri del Lavoro, 13 - 37059 S. Maria di Zevio - Verona - Italy
Tel. +39 045 8774222 - Fax +39 045 8750303 - E-mail: com@comac.it
www.comac.it